

VERTICAL SERIES BOOSTER PUMPS

Stainless Steel Vertical Multistage Centrifugal Pump



The Webtrol V Series

Vertical multistage pumps offer technically advanced designs to meet market demands including hot water applications.

Every Webtrol V Series pump is hand assembled and checked during each step of the assembly process up to the final test where each pump is checked for flow, pressure, power consumption, leaks, vibration and noise.

Features / Benefits

Space saving vertical design.

Floating outer casing allows for thermal expansion in hot water application and is flexible preventing deformation due to pressure fluctuations.

Unique bulge forming process produces rugged construction with increased wall thickness and assures component integrity.

All wetted parts are constructed of high quality stainless steel. Available in 304 and 316 stainless steel.

Robust construction extends to critical internal components such as the impellers. The back shrouds are as much as three times thicker than the front shrouds while front shrouds are 20% to 60% thicker than comparable designs.

Performance

Capacities to 375 GPM

Pressures to 360 PSI

Temperature to 248° F

Typical Services

- Water Supply
- Reverse Osmosis
- Water Boosting
- Washing Systems
- Fire Fighting
- Water Treatment
- Filtration
- Plants
- Boiler Feed
- Hot & Cold Water
- Circulation
- Irrigation
- Sprinkler Systems
- Heat Exchangers

VERTICAL FAMILY SERIES

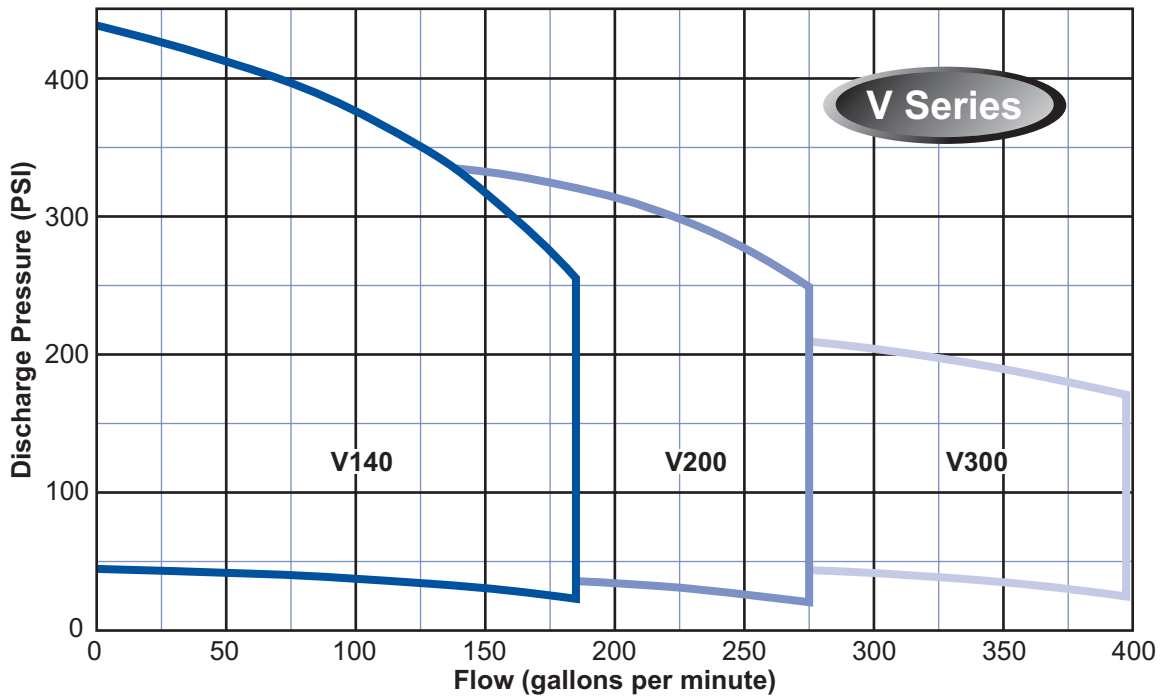
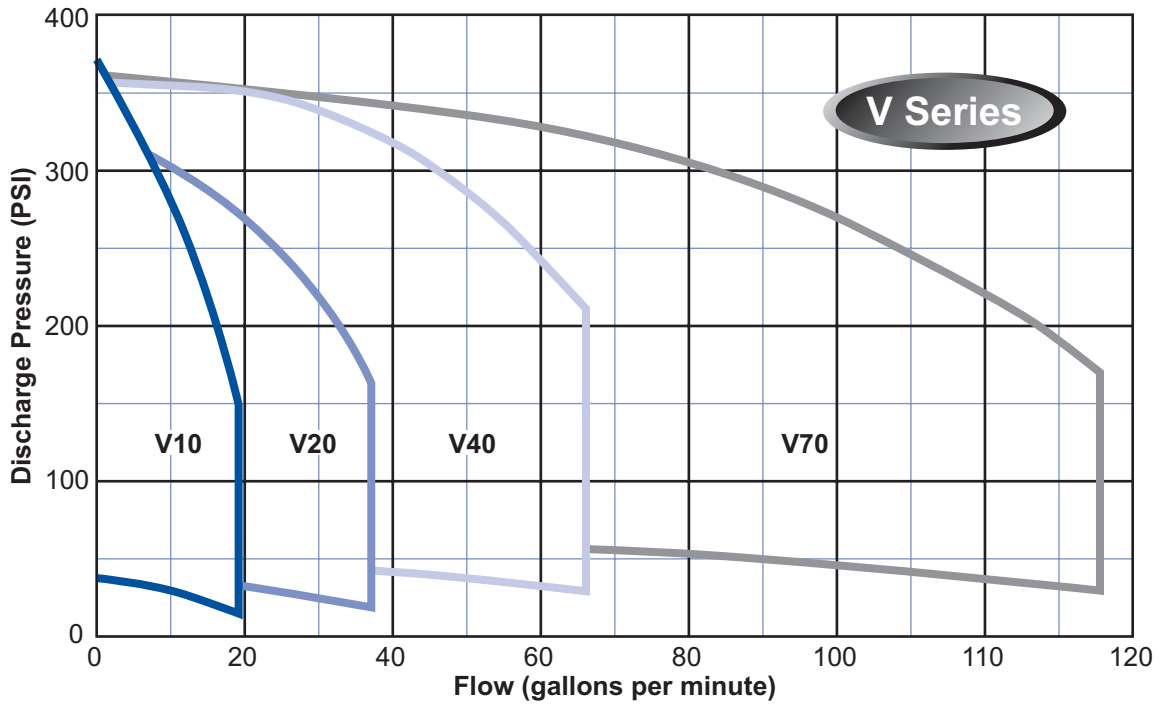

VERTICAL SERIES GROUP CURVES

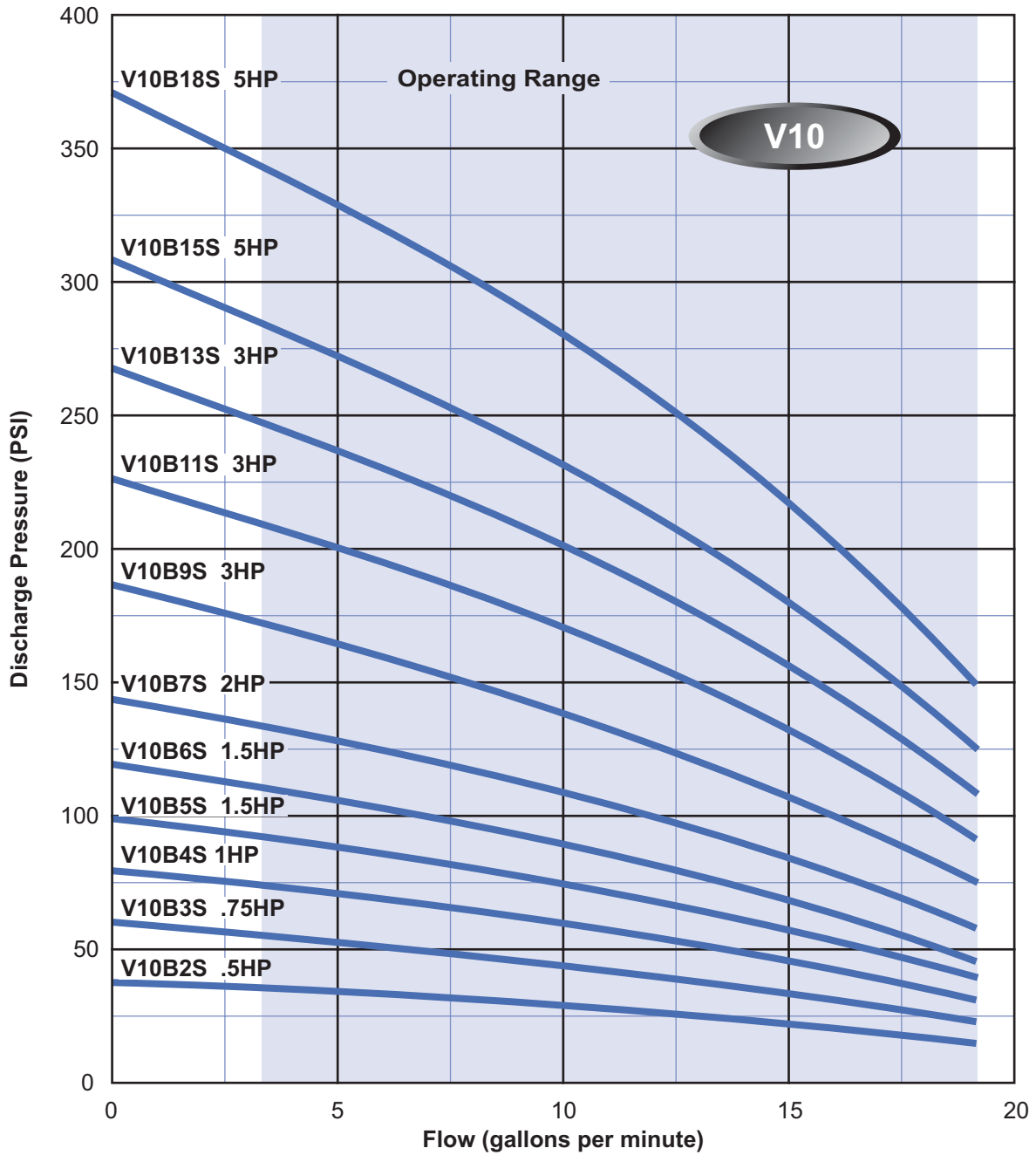

VERTICAL SERIES GROUP CURVES

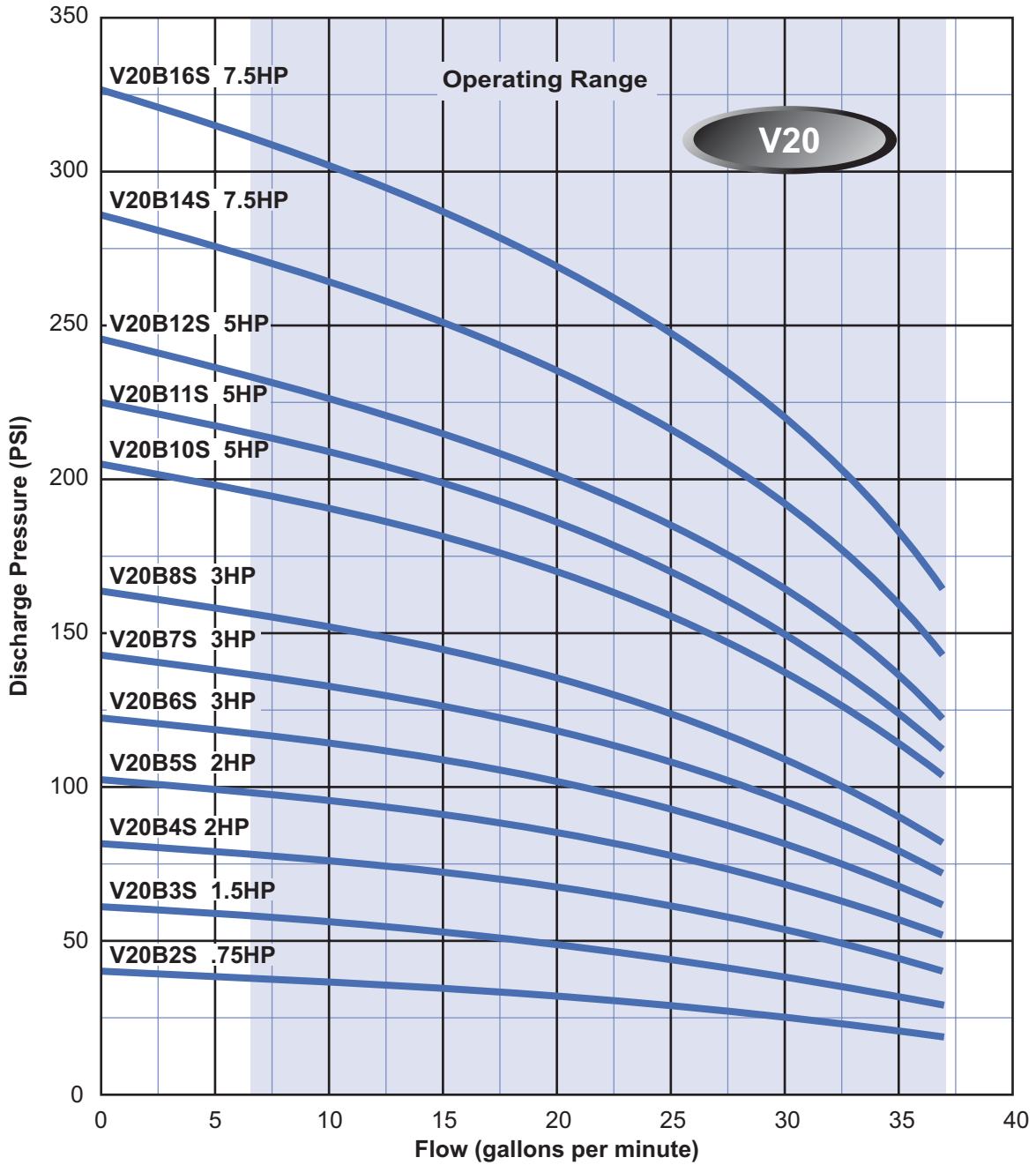

VERTICAL SERIES GROUP CURVES

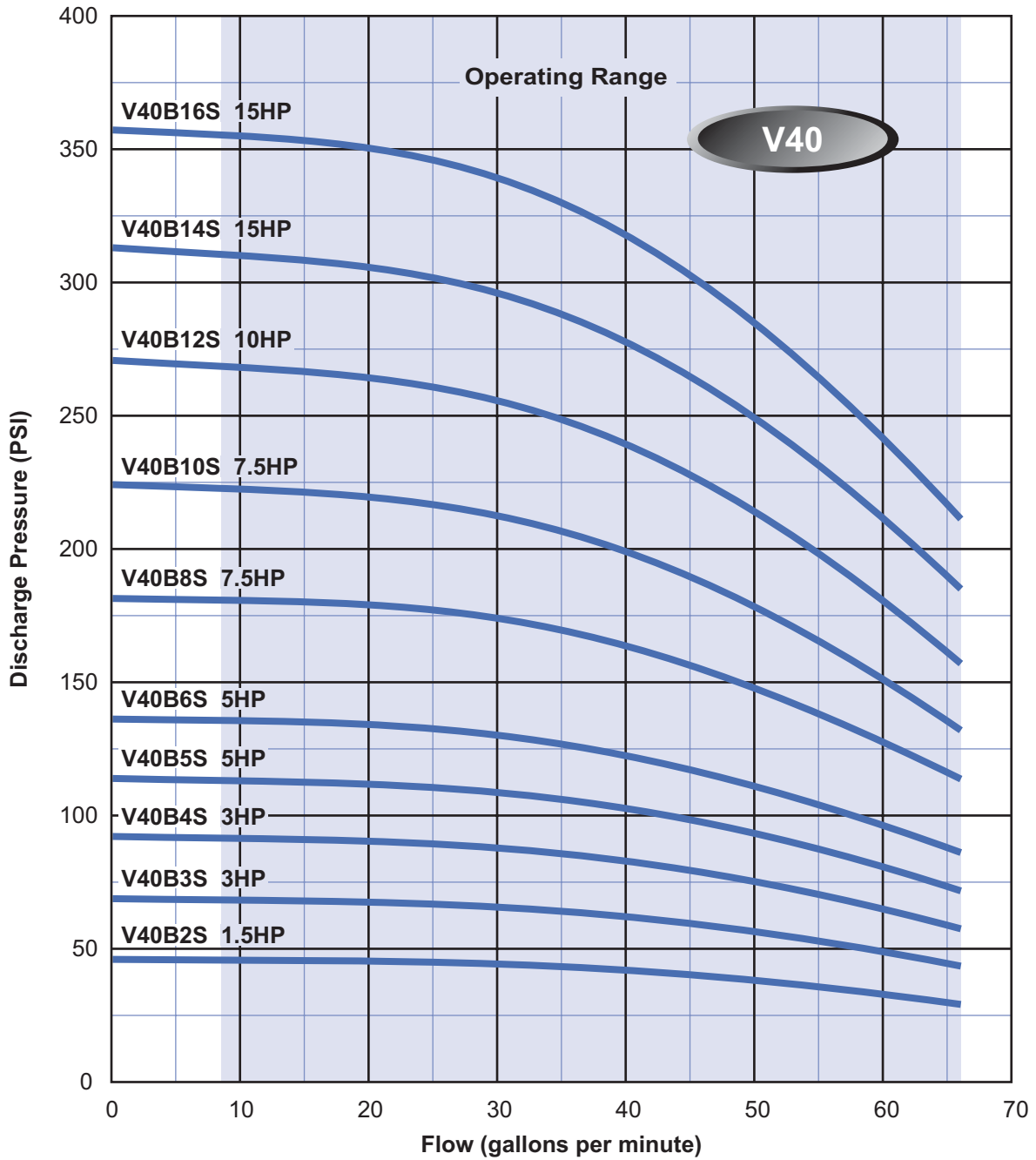

VERTICAL SERIES GROUP CURVES

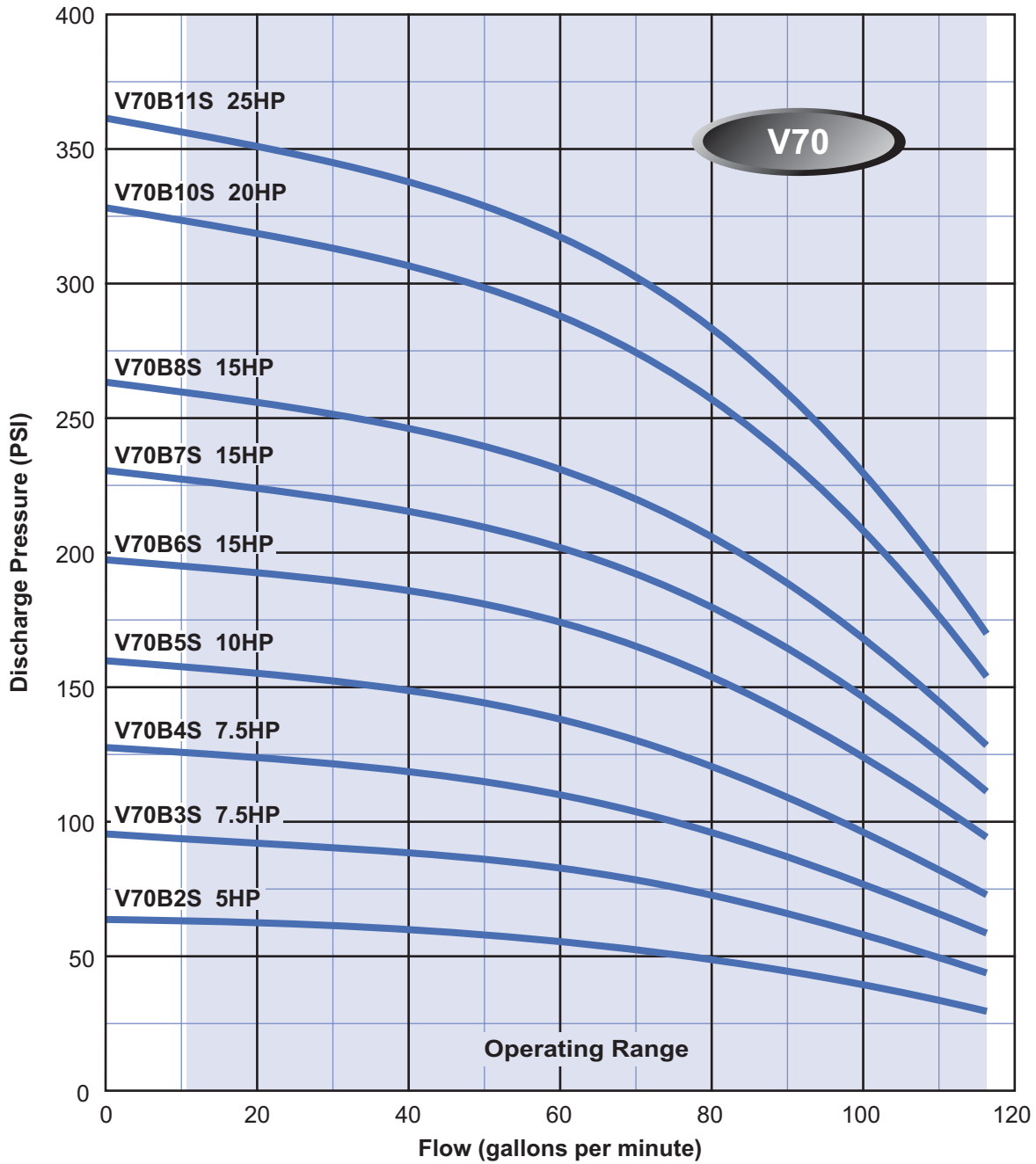

VERTICAL SERIES GROUP CURVES

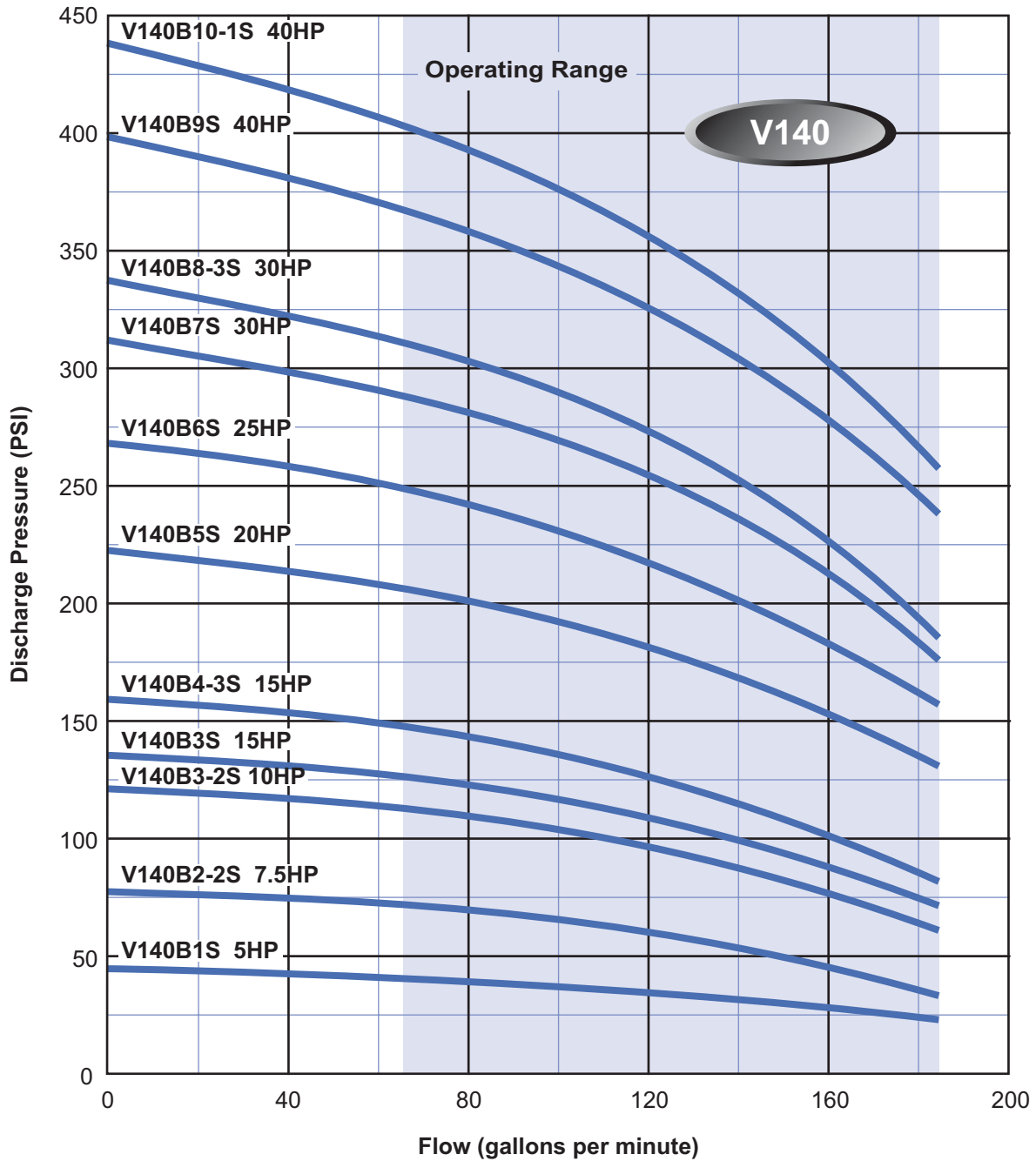

VERTICAL SERIES GROUP CURVES

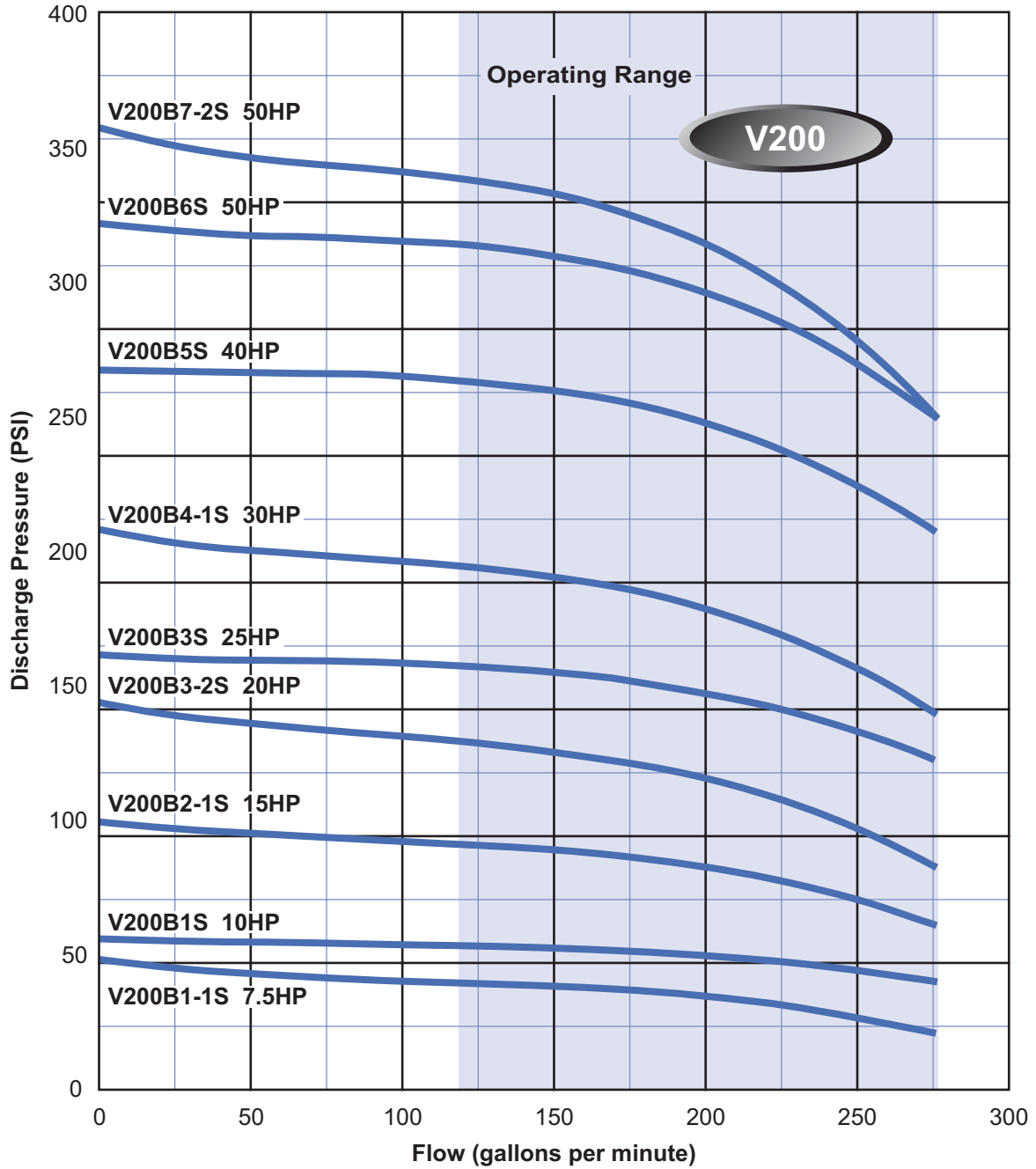

VERTICAL SERIES GROUP CURVES

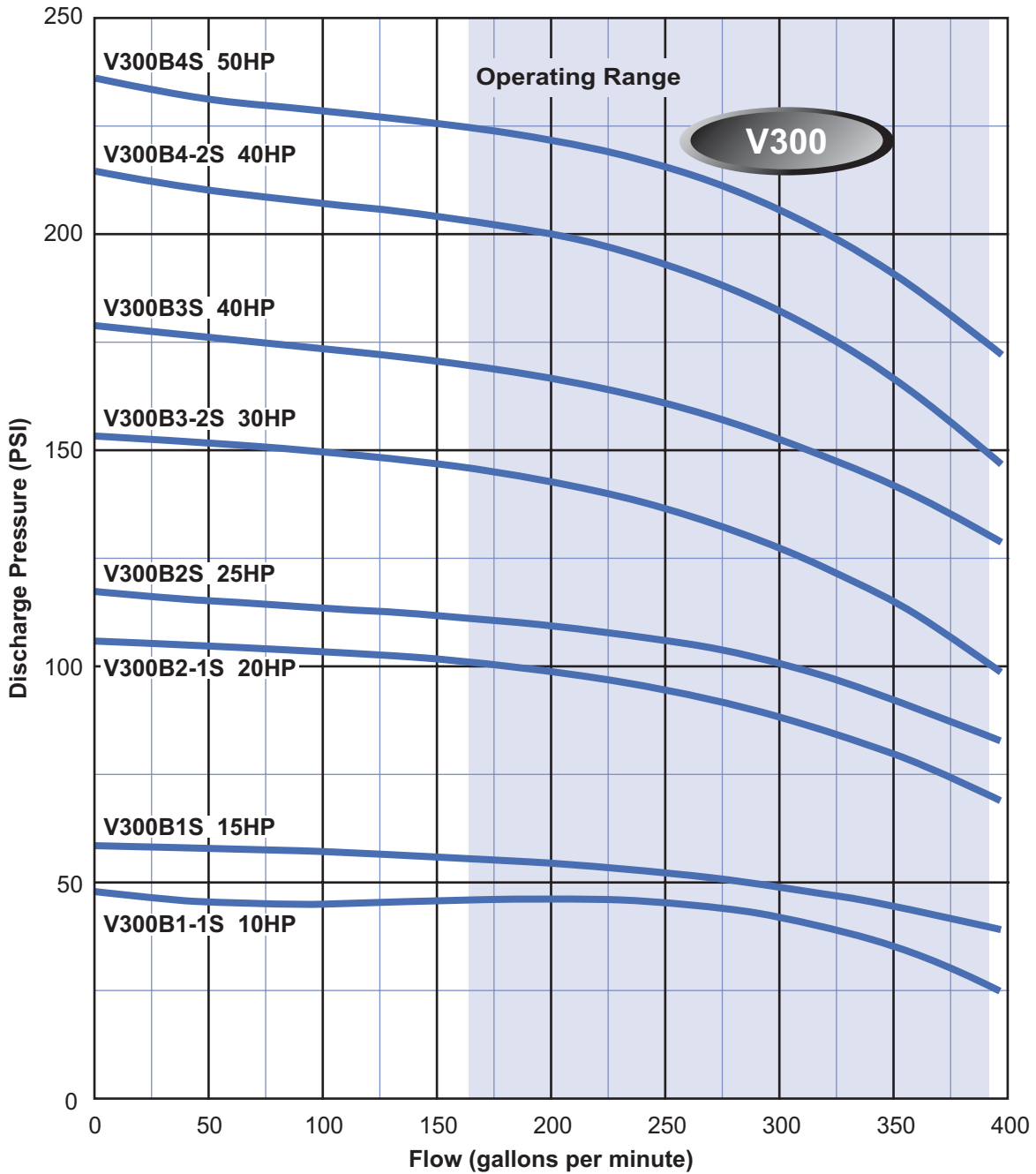

VERTICAL SERIES BOOSTER - 10 Series

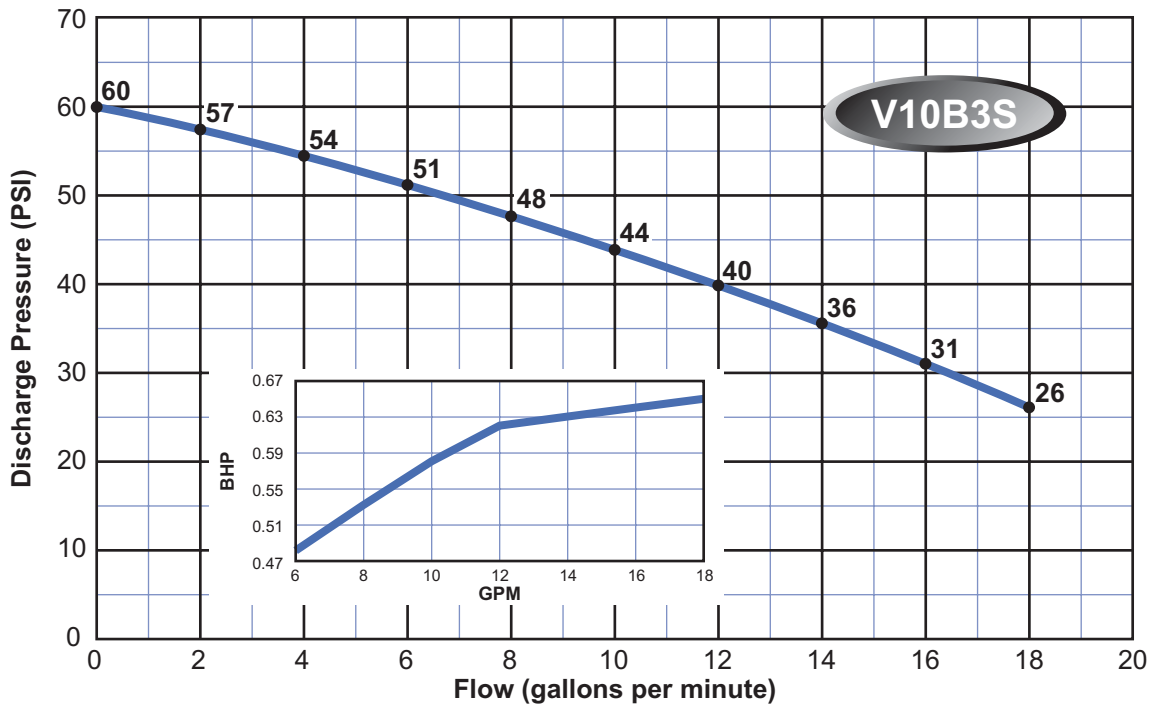
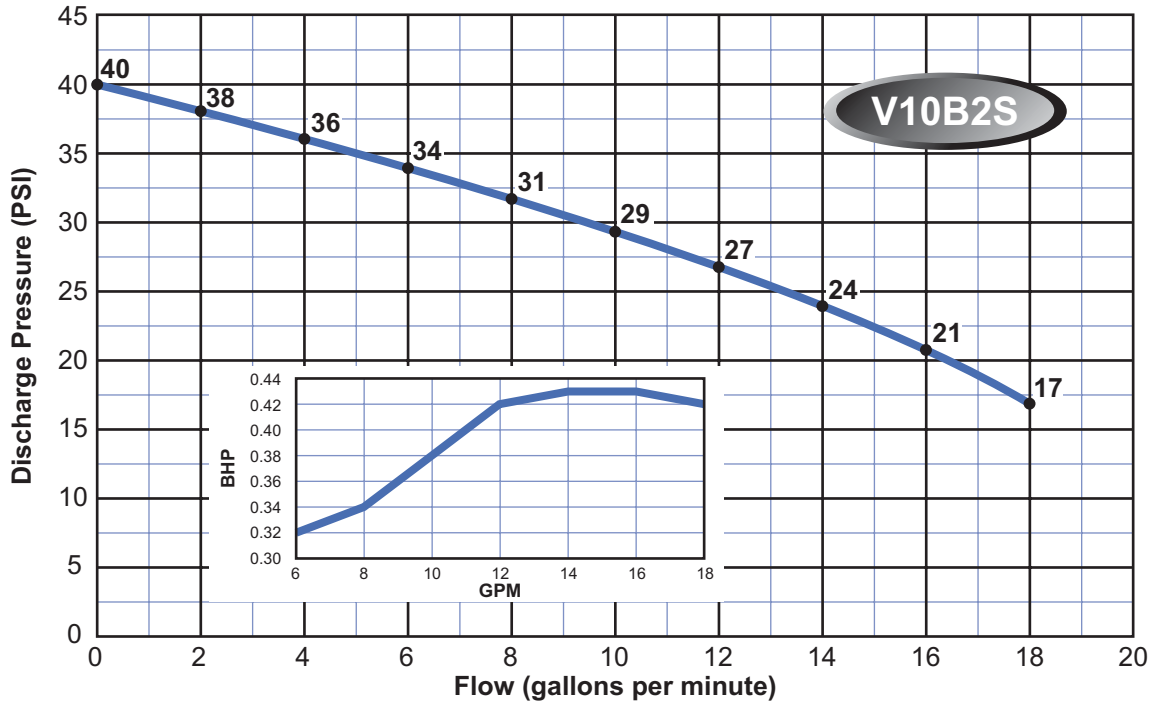

Note:

Curves are based on 60 Hz 3450 rpm motors. 50 Hz 2875 rpm curves are available. These curves are for general guidance only, individual pump curves are available upon request. A certified curve may be requested for an additional cost. Webtrol will build pumps to fit your specific needs, contact factory for pricing.

VERTICAL SERIES BOOSTER - 10 Series

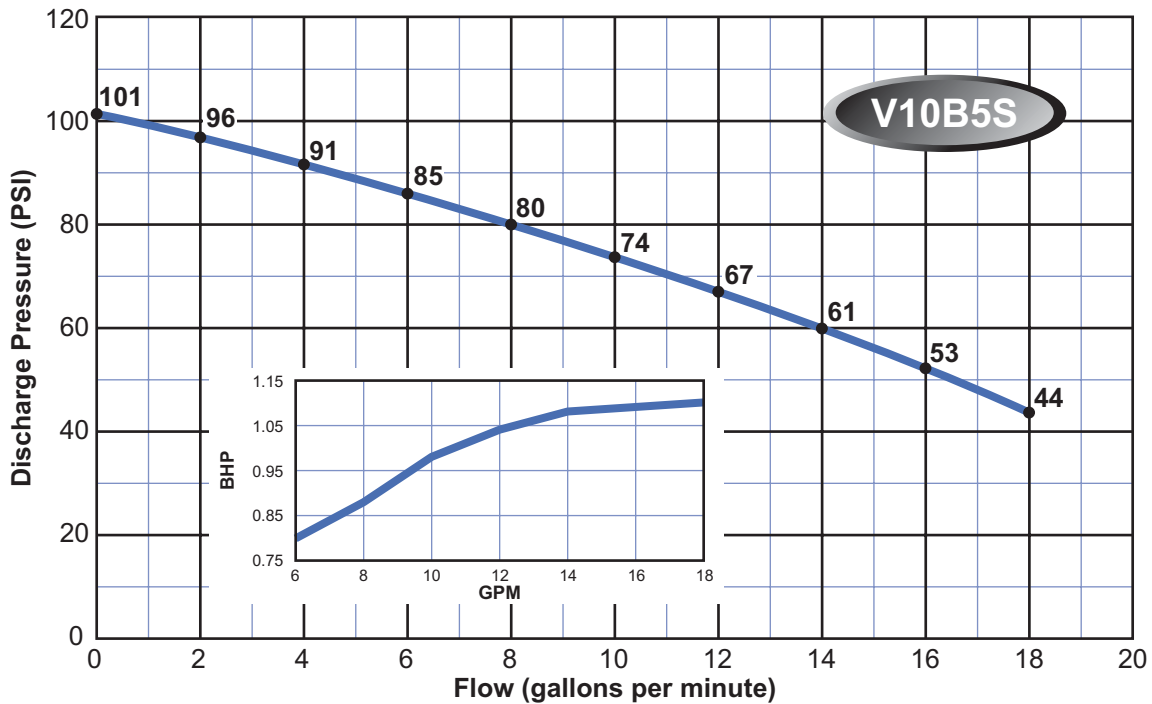
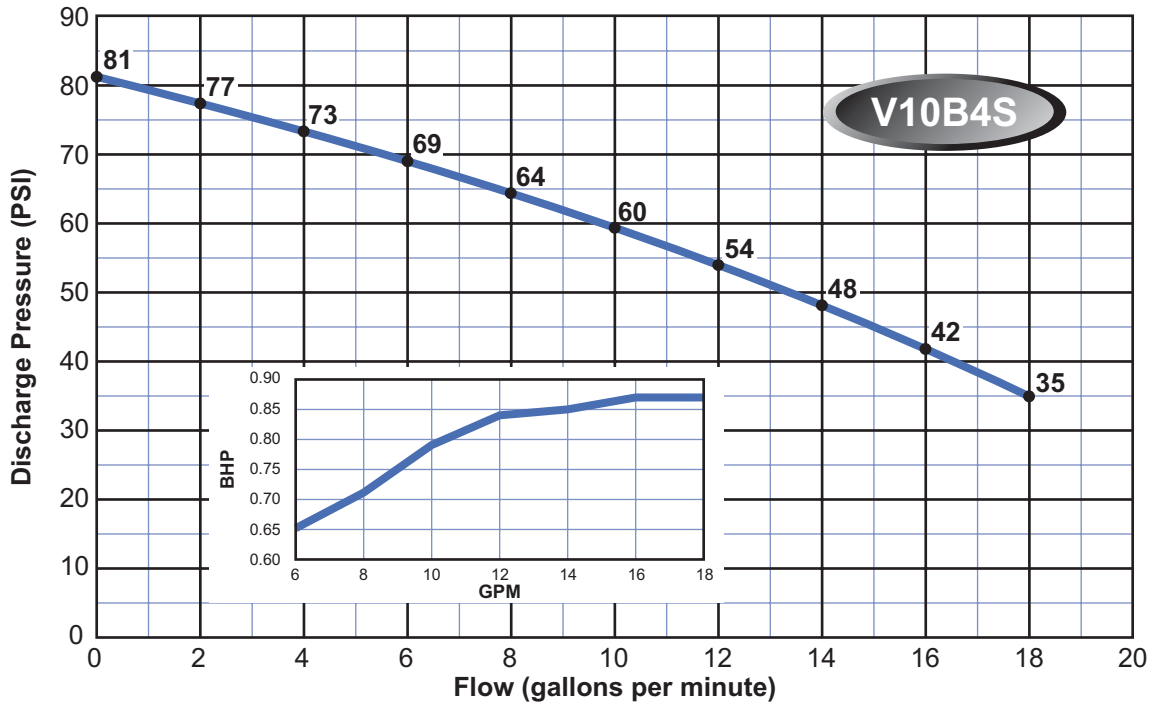

Note:

Curves are based on 60 Hz 3450 rpm motors. 50 Hz 2875 rpm curves are available. These curves are for general guidance only, individual pump curves are available upon request. A certified curve may be requested for an additional cost. Webtrol will build pumps to fit your specific needs, contact factory for pricing.

VERTICAL SERIES BOOSTER - 10 Series

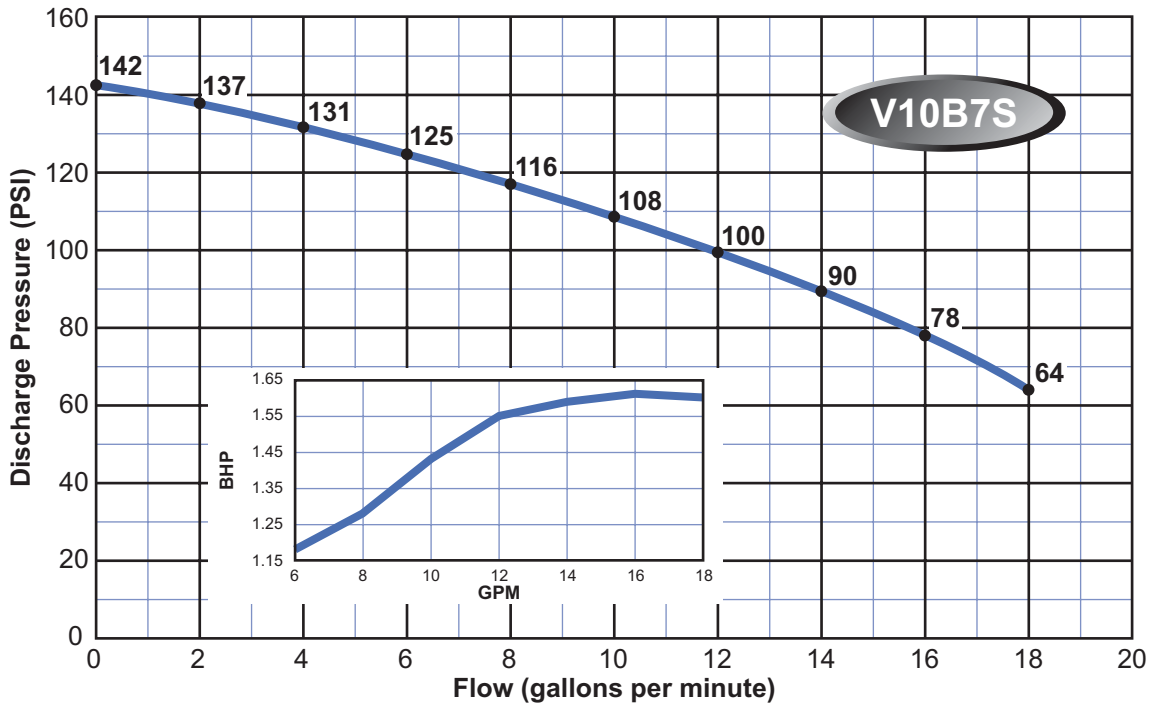
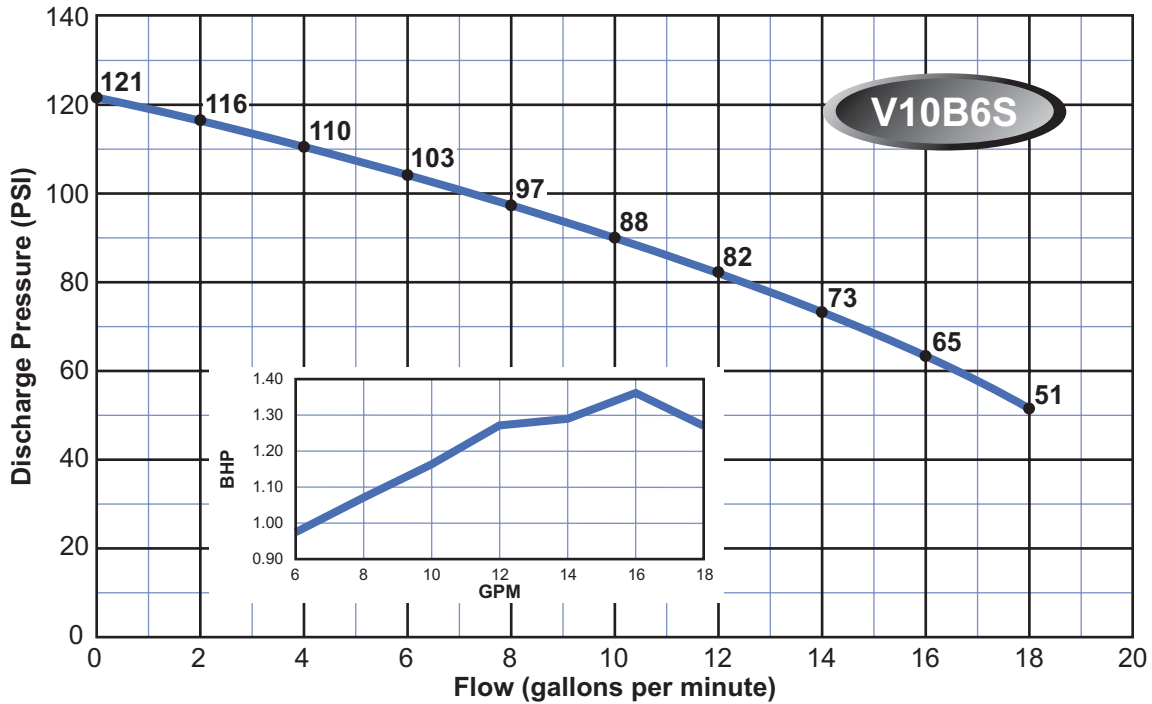

Note:

Curves are based on 60 Hz 3450 rpm motors. 50 Hz 2875 rpm curves are available. These curves are for general guidance only, individual pump curves are available upon request. A certified curve may be requested for an additional cost. Webtrol will build pumps to fit your specific needs, contact factory for pricing.

VERTICAL SERIES BOOSTER - 10 Series

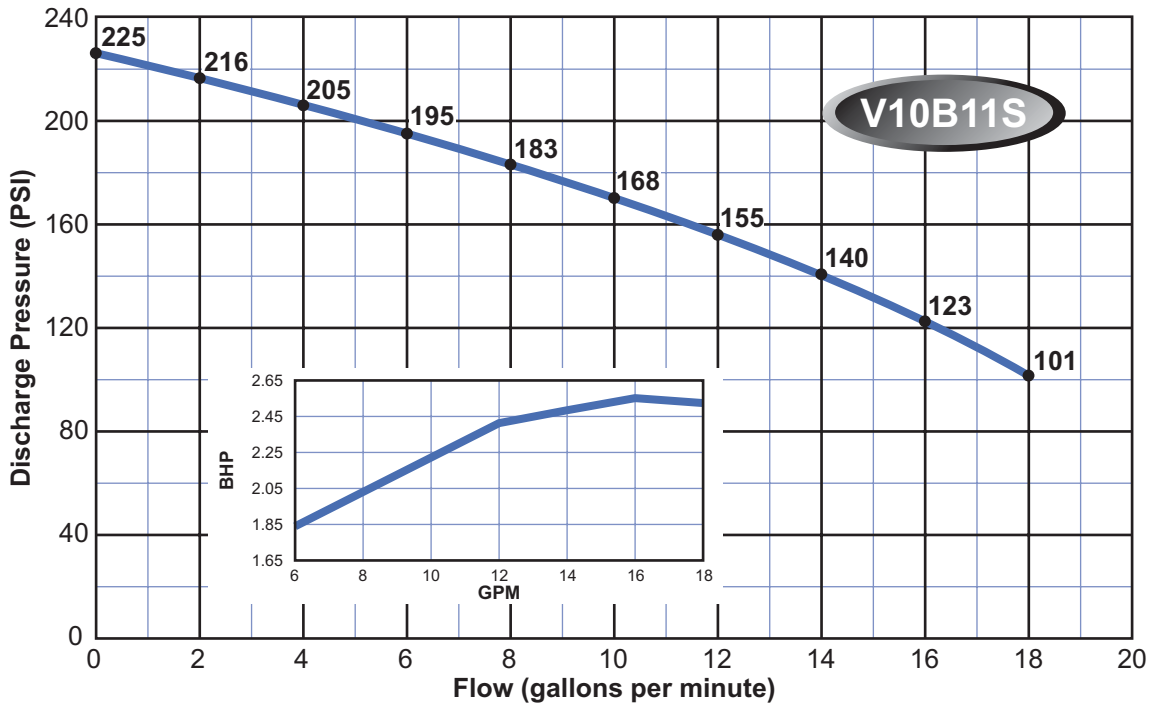
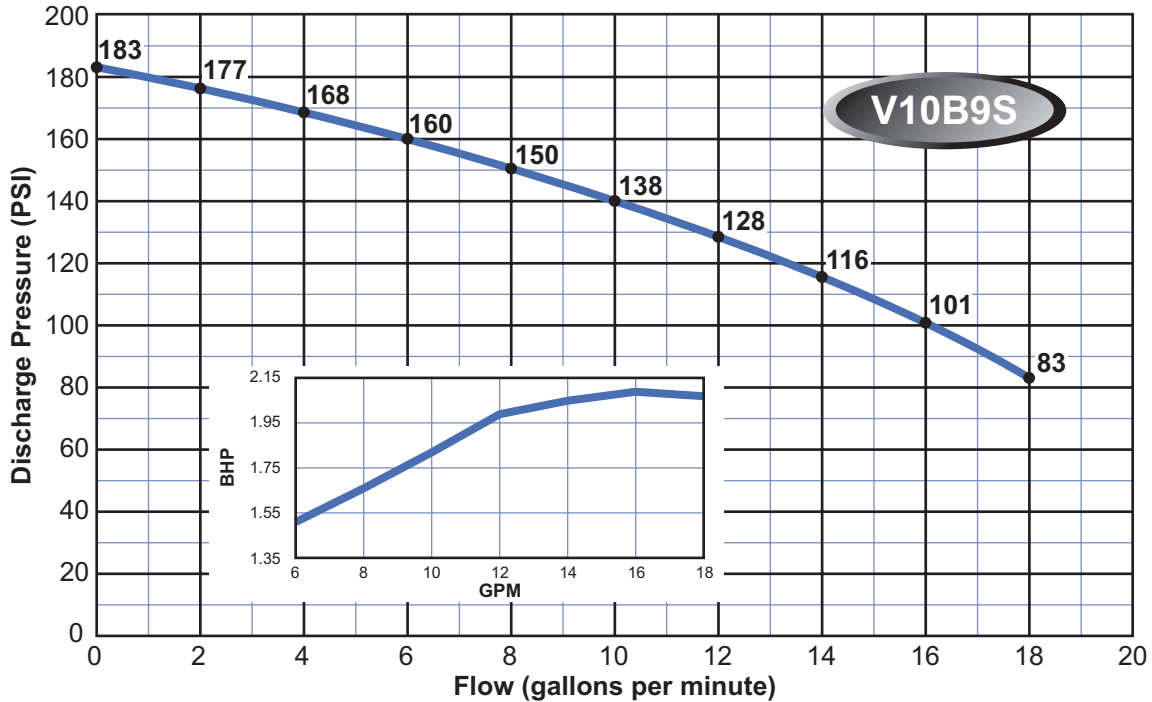

Note:

Curves are based on 60 Hz 3450 rpm motors. 50 Hz 2875 rpm curves are available. These curves are for general guidance only, individual pump curves are available upon request. A certified curve may be requested for an additional cost. Webtrol will build pumps to fit your specific needs, contact factory for pricing.

VERTICAL SERIES BOOSTER - 10 Series

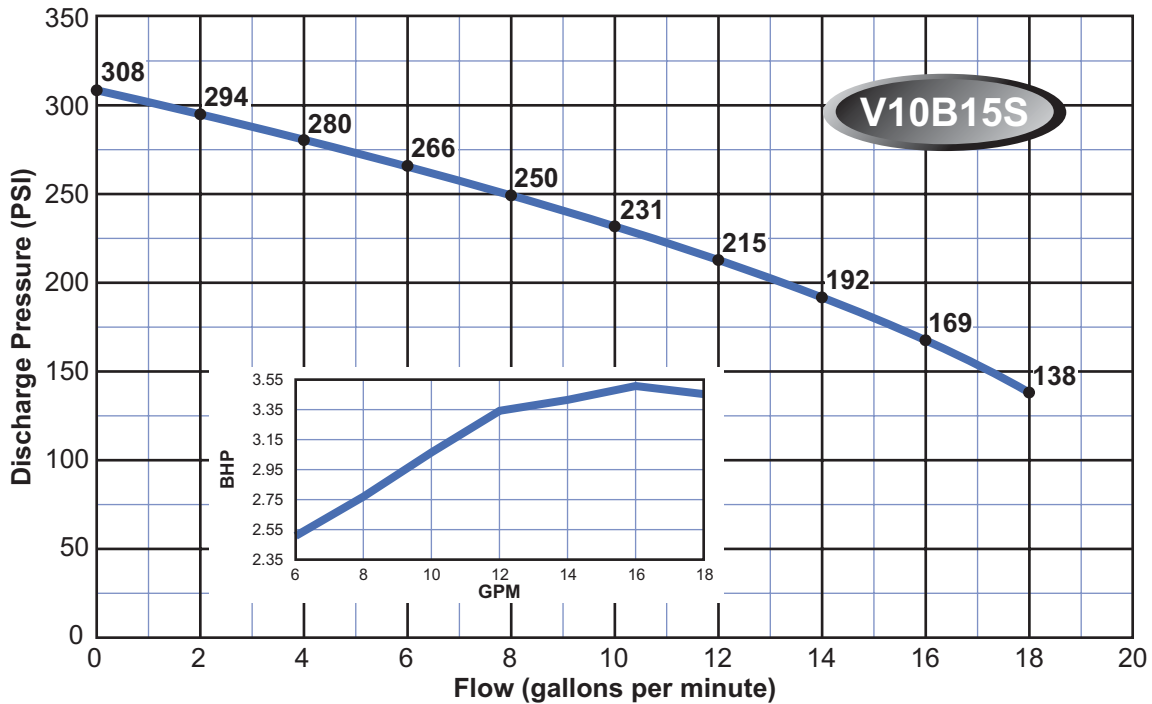
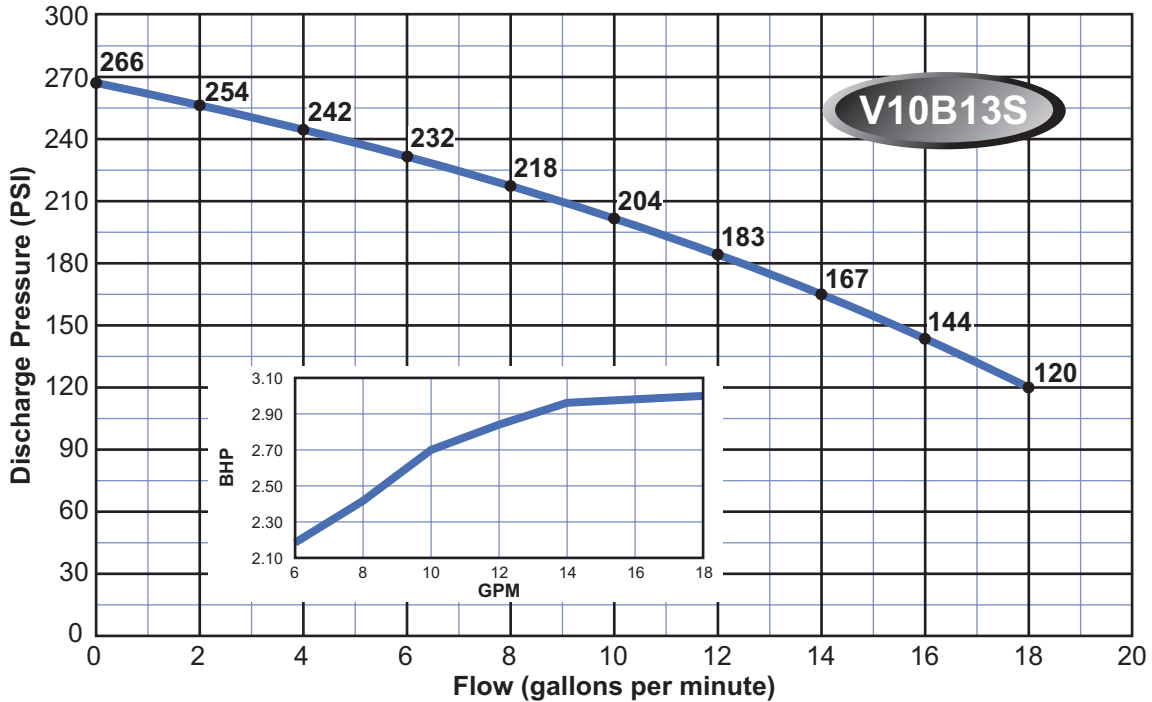

Note:

Curves are based on 60 Hz 3450 rpm motors. 50 Hz 2875 rpm curves are available. These curves are for general guidance only, individual pump curves are available upon request. A certified curve may be requested for an additional cost. Webtrol will build pumps to fit your specific needs, contact factory for pricing.

VERTICAL SERIES BOOSTER - 10 Series

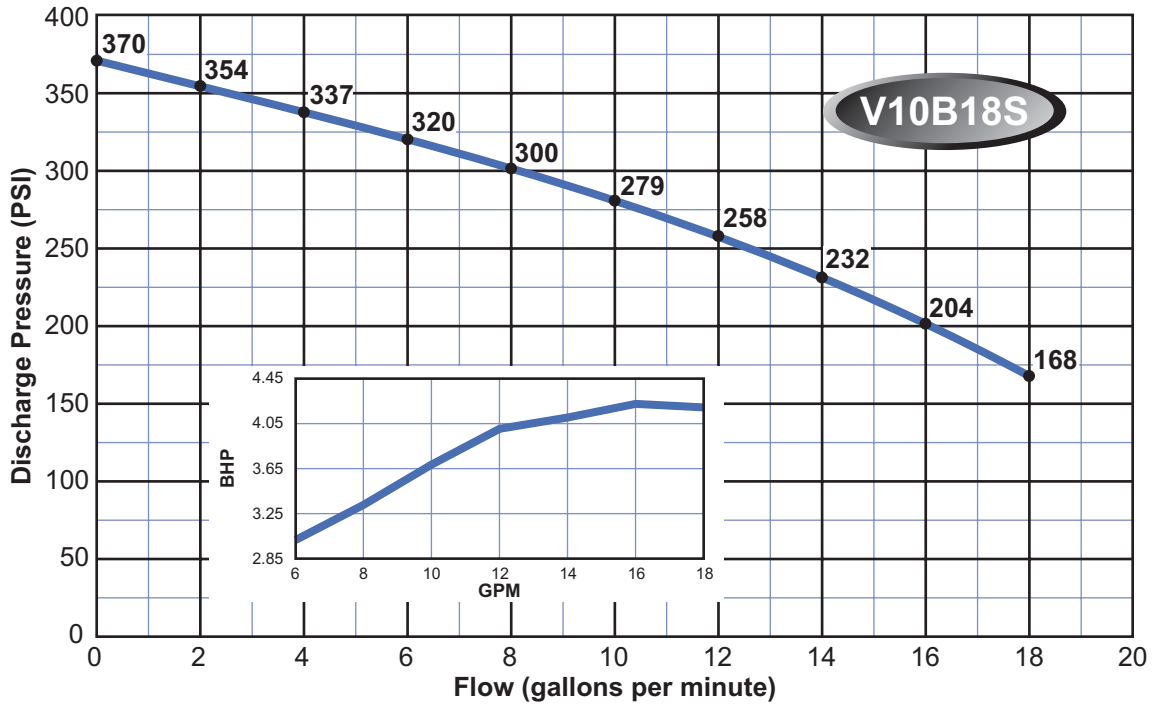

Note:

Curves are based on 60 Hz 3450 rpm motors. 50 Hz 2875 rpm curves are available. These curves are for general guidance only, individual pump curves are available upon request. A certified curve may be requested for an additional cost. Webtrol will build pumps to fit your specific needs, contact factory for pricing.

VERTICAL SERIES BOOSTER - 20 Series

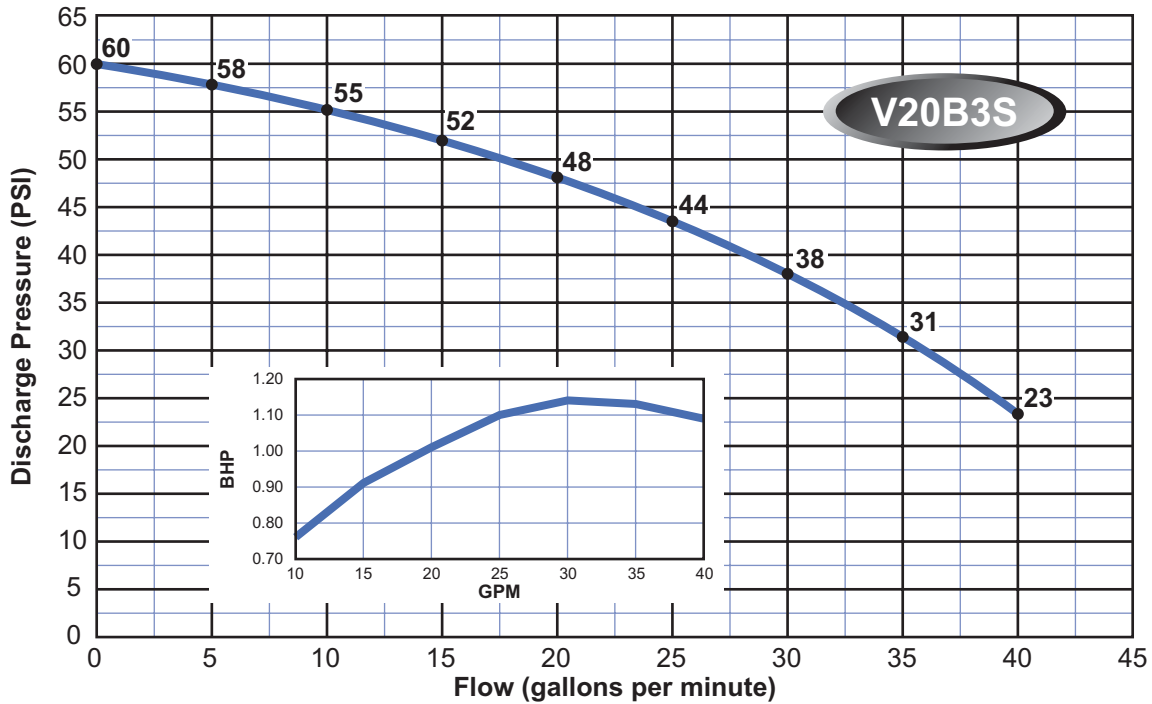
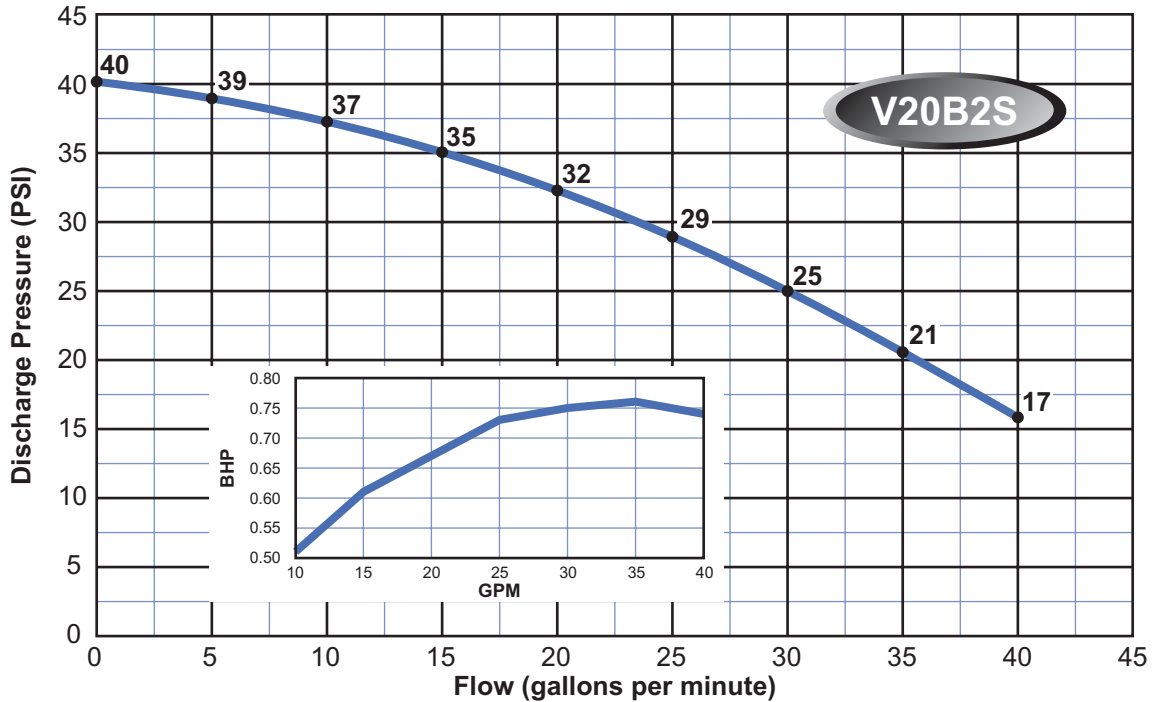

Note:

Curves are based on 60 Hz 3450 rpm motors. 50 Hz 2875 rpm curves are available. These curves are for general guidance only, individual pump curves are available upon request. A certified curve may be requested for an additional cost. Webtrol will build pumps to fit your specific needs, contact factory for pricing.

VERTICAL SERIES BOOSTER - 20 Series

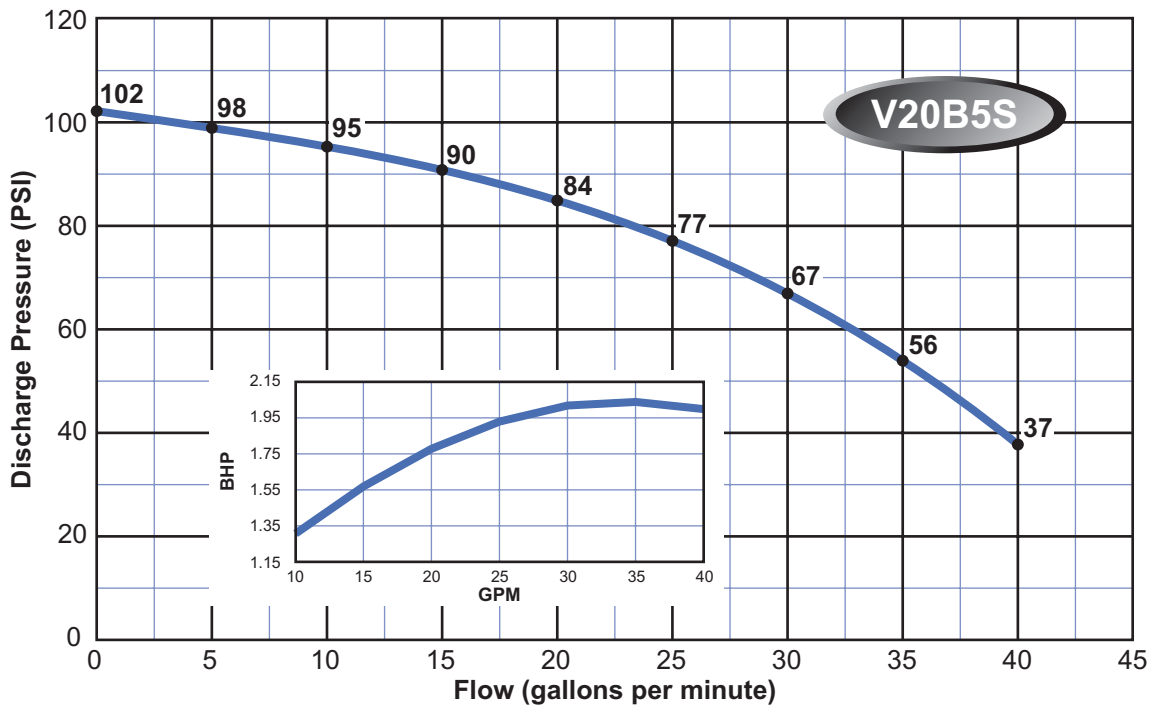
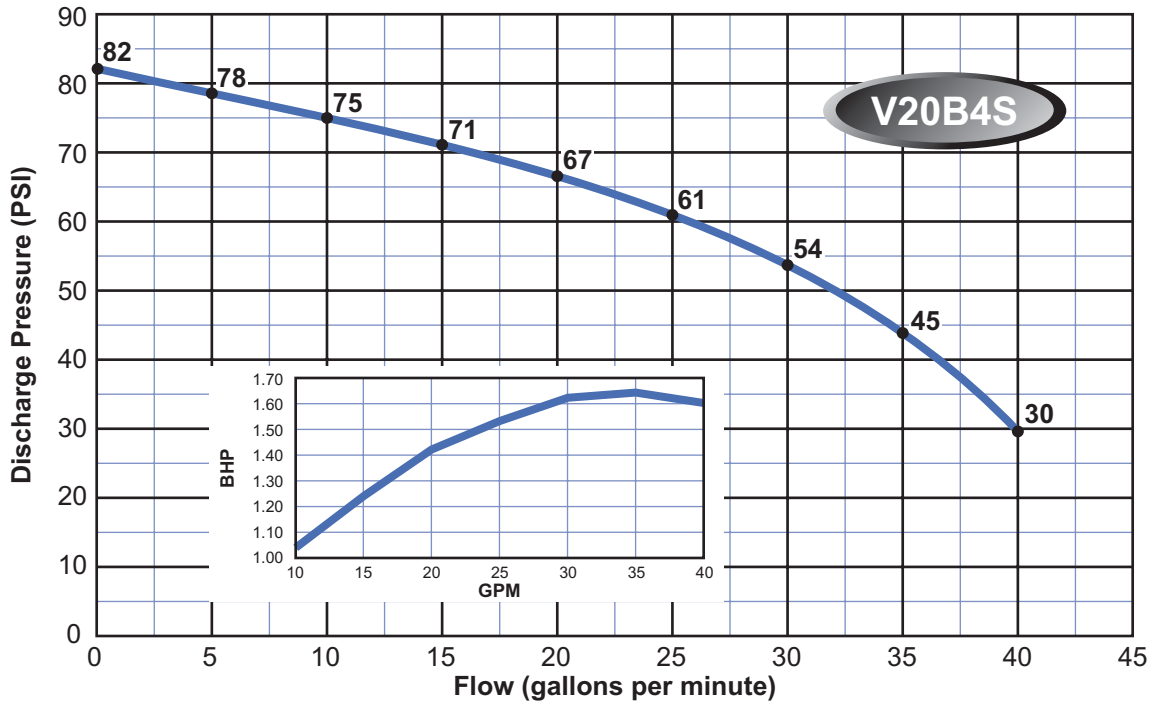

Note:

Curves are based on 60 Hz 3450 rpm motors. 50 Hz 2875 rpm curves are available. These curves are for general guidance only, individual pump curves are available upon request. A certified curve may be requested for an additional cost. Webtrol will build pumps to fit your specific needs, contact factory for pricing.

VERTICAL SERIES BOOSTER - 20 Series

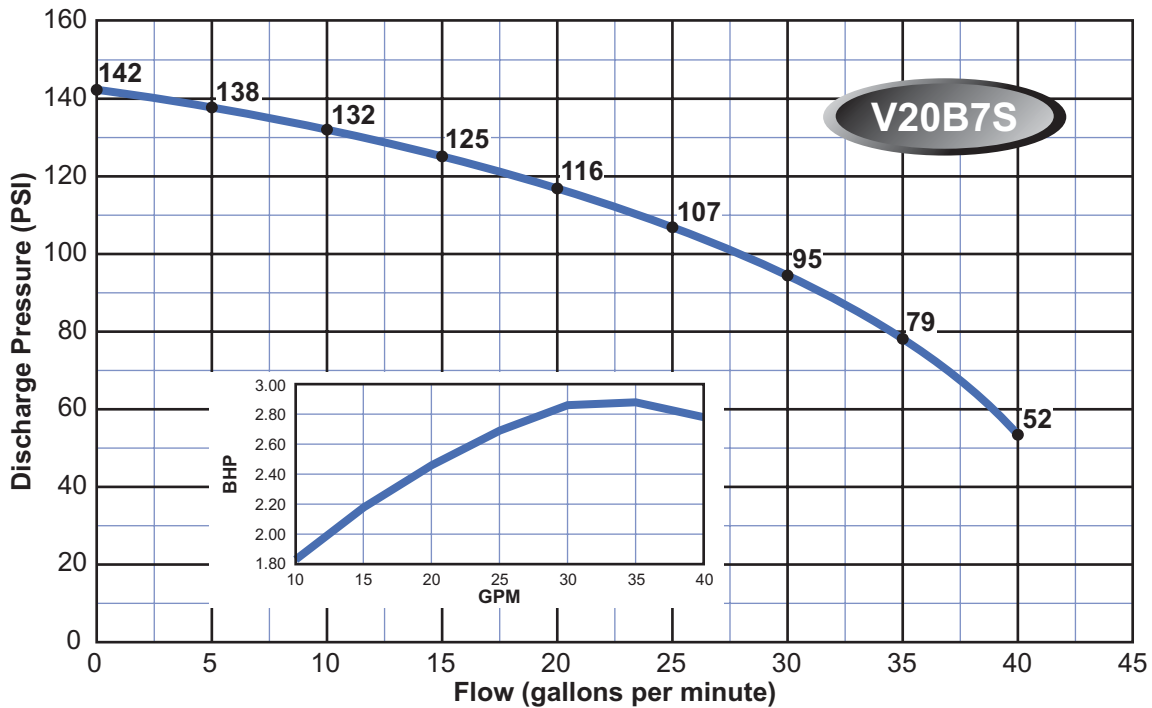
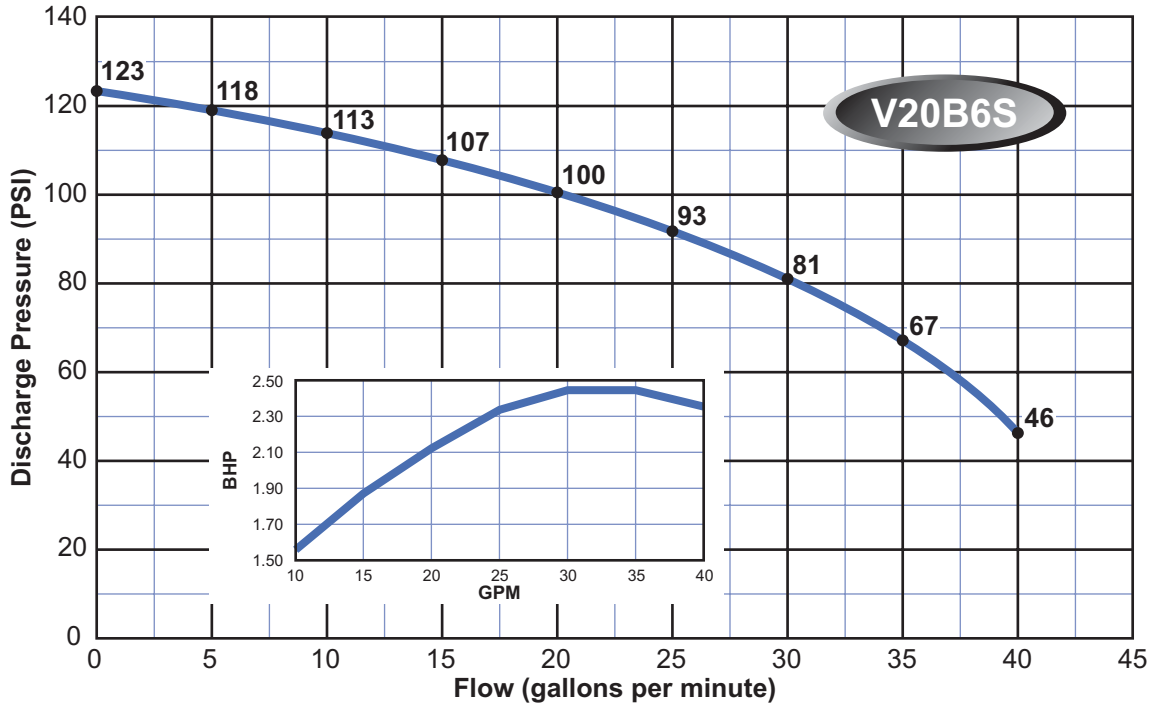

Note:

Curves are based on 60 Hz 3450 rpm motors. 50 Hz 2875 rpm curves are available. These curves are for general guidance only, individual pump curves are available upon request. A certified curve may be requested for an additional cost. Webtrol will build pumps to fit your specific needs, contact factory for pricing.

VERTICAL SERIES BOOSTER - 20 Series

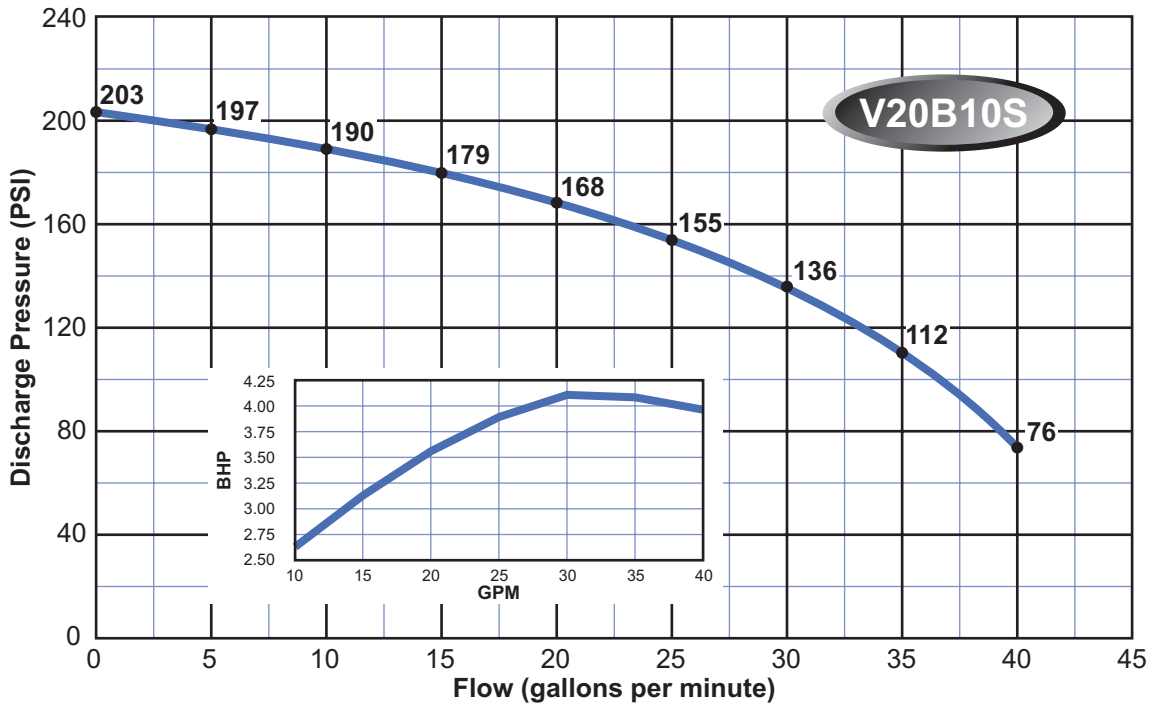
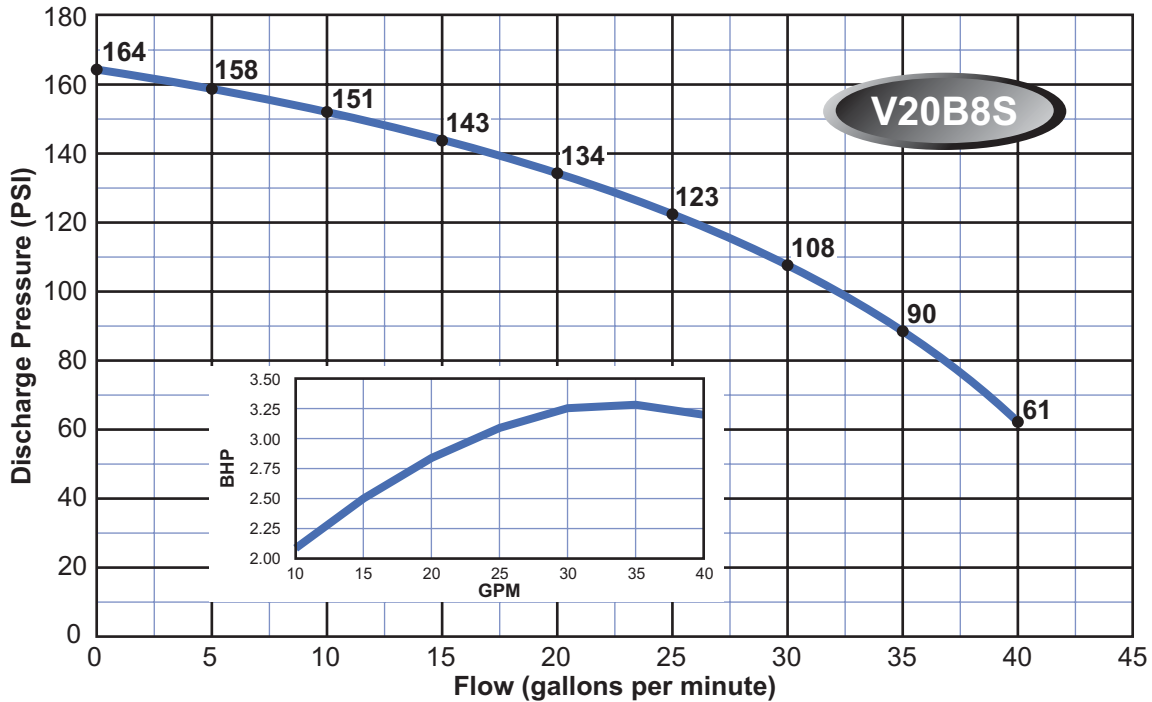

Note:

Curves are based on 60 Hz 3450 rpm motors. 50 Hz 2875 rpm curves are available. These curves are for general guidance only, individual pump curves are available upon request. A certified curve may be requested for an additional cost. Webtrol will build pumps to fit your specific needs, contact factory for pricing.

VERTICAL SERIES BOOSTER - 20 Series

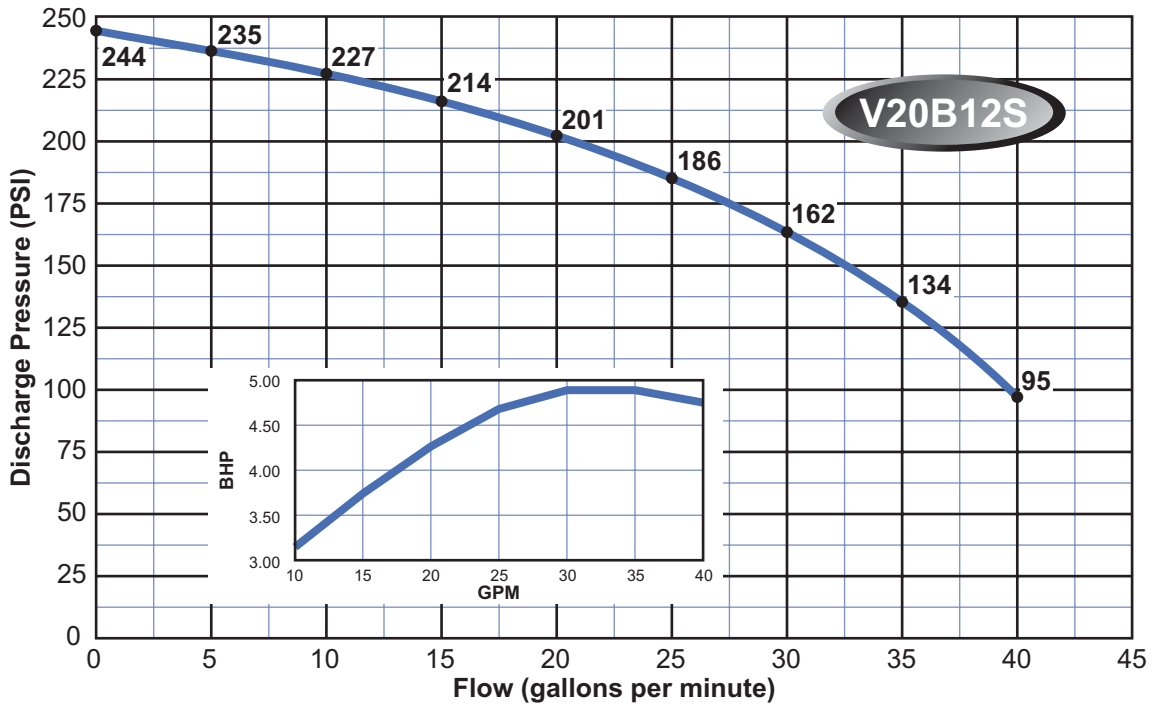
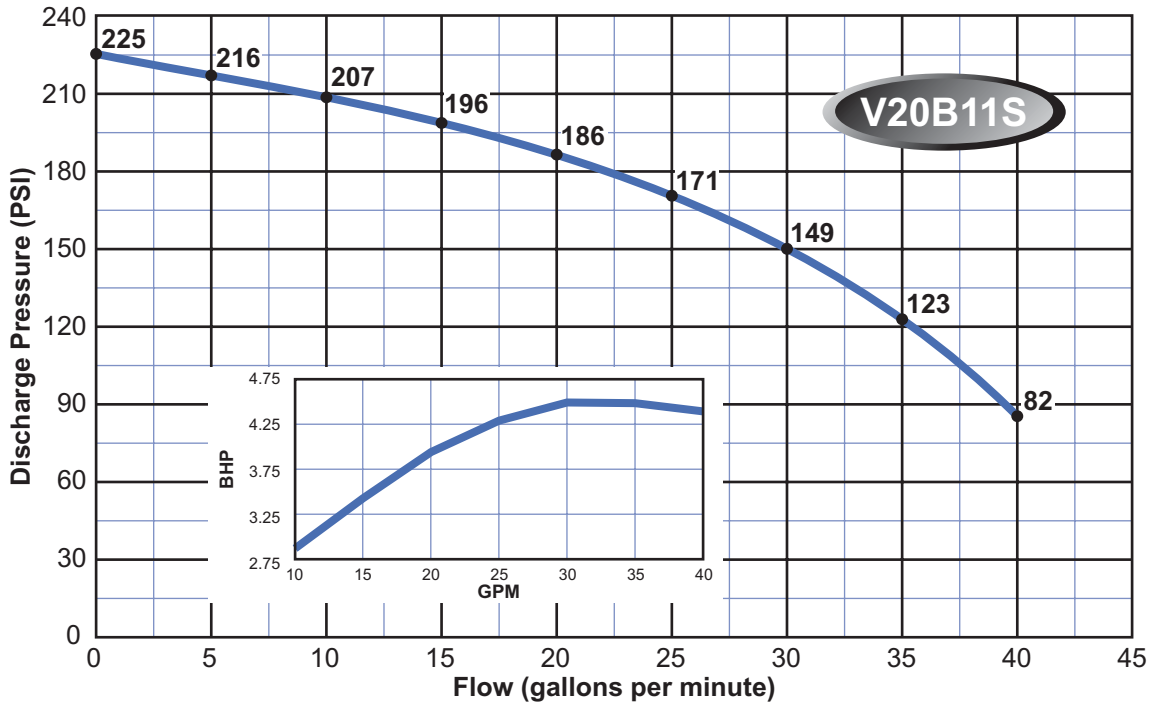

Note:

Curves are based on 60 Hz 3450 rpm motors. 50 Hz 2875 rpm curves are available. These curves are for general guidance only, individual pump curves are available upon request. A certified curve may be requested for an additional cost. Webtrol will build pumps to fit your specific needs, contact factory for pricing.

VERTICAL SERIES BOOSTER - 20 Series

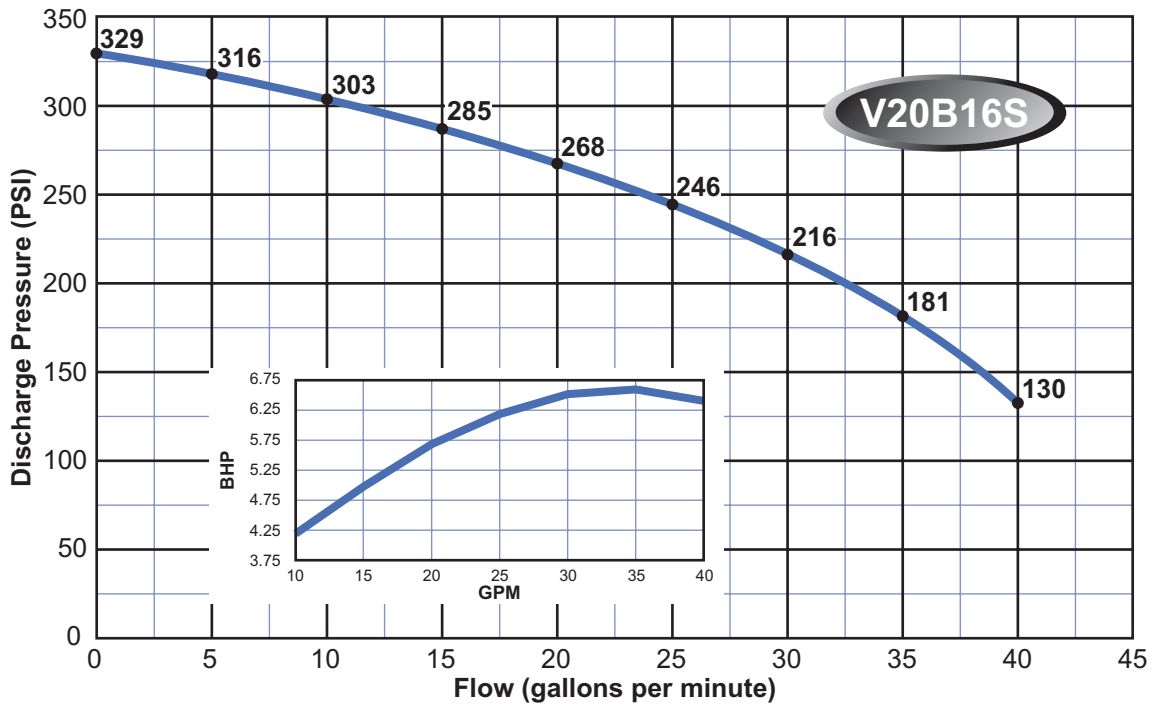
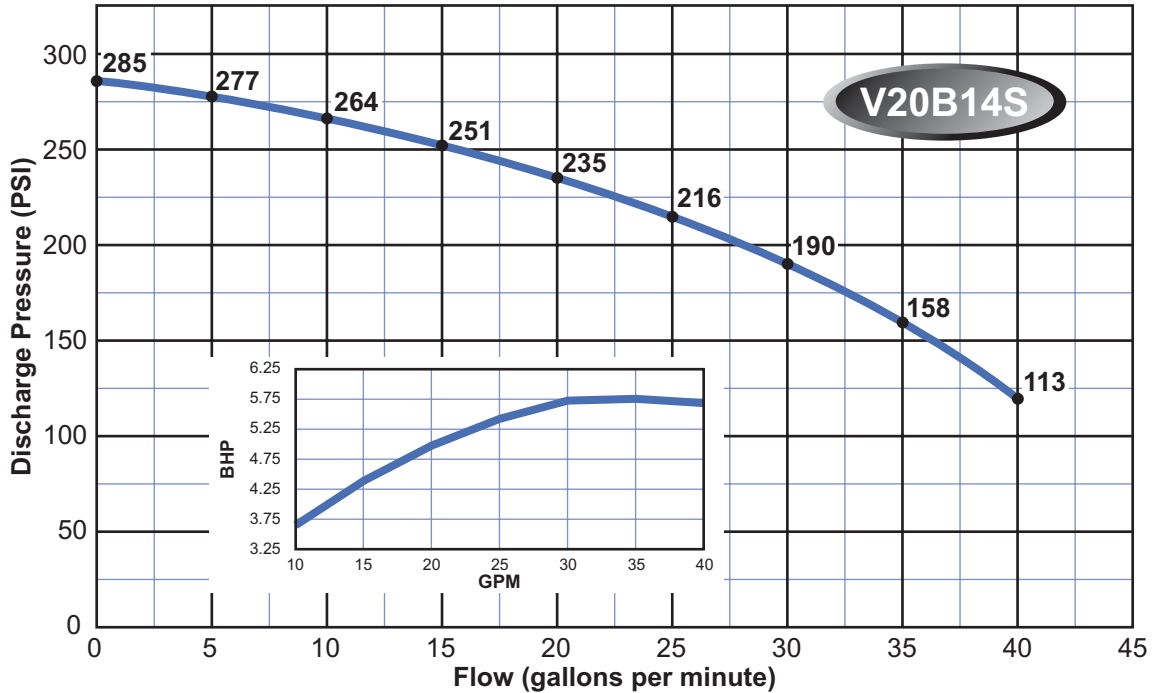

Note:

Curves are based on 60 Hz 3450 rpm motors. 50 Hz 2875 rpm curves are available. These curves are for general guidance only, individual pump curves are available upon request. A certified curve may be requested for an additional cost. Webtrol will build pumps to fit your specific needs, contact factory for pricing.

VERTICAL SERIES BOOSTER - 40 Series

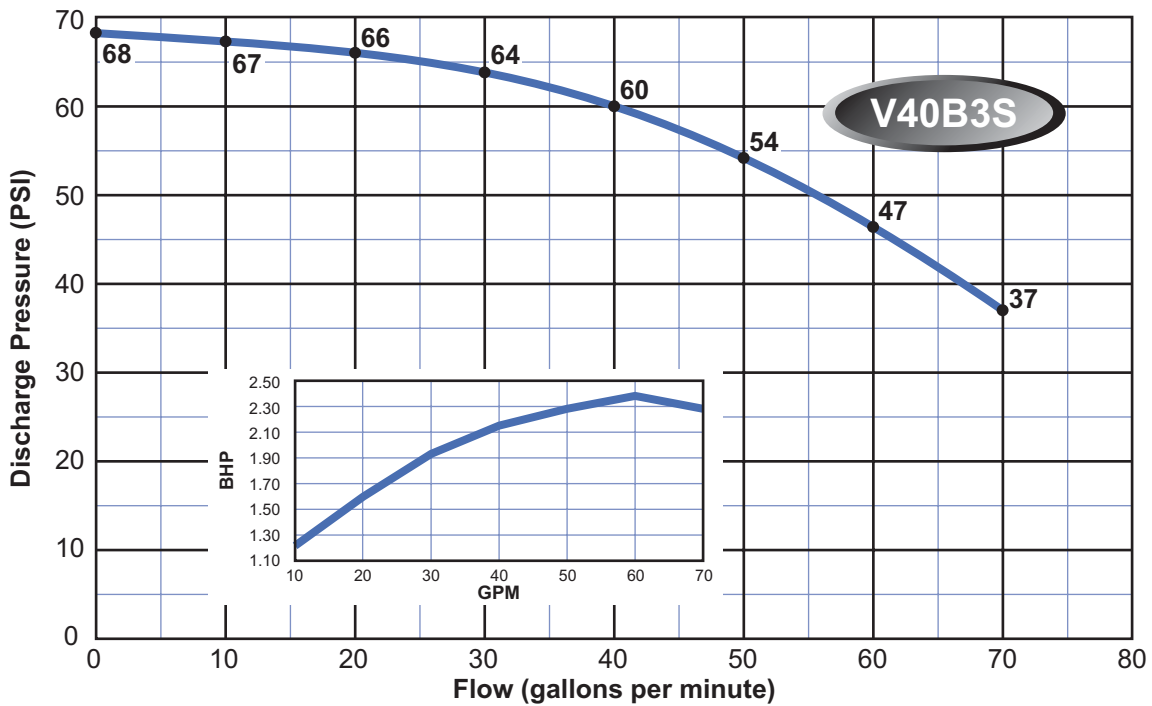
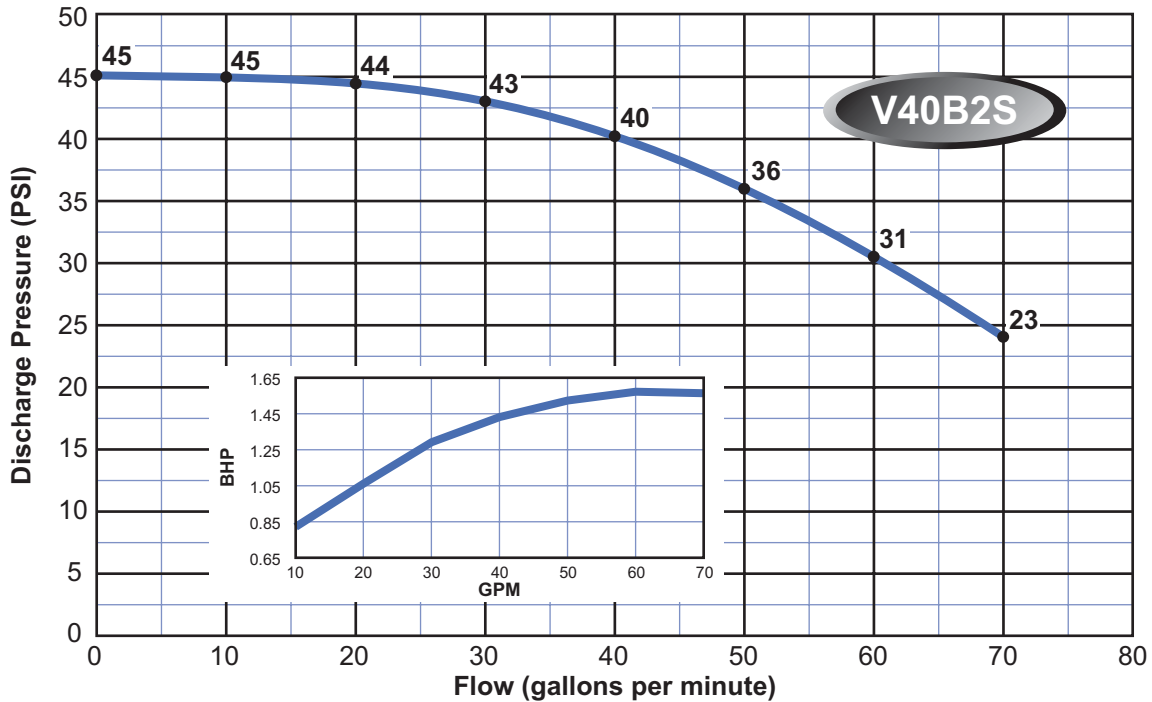

Note:

Curves are based on 60 Hz 3450 rpm motors. 50 Hz 2875 rpm curves are available. These curves are for general guidance only, individual pump curves are available upon request. A certified curve may be requested for an additional cost. Webtrol will build pumps to fit your specific needs, contact factory for pricing.

VERTICAL SERIES BOOSTER - 40 Series

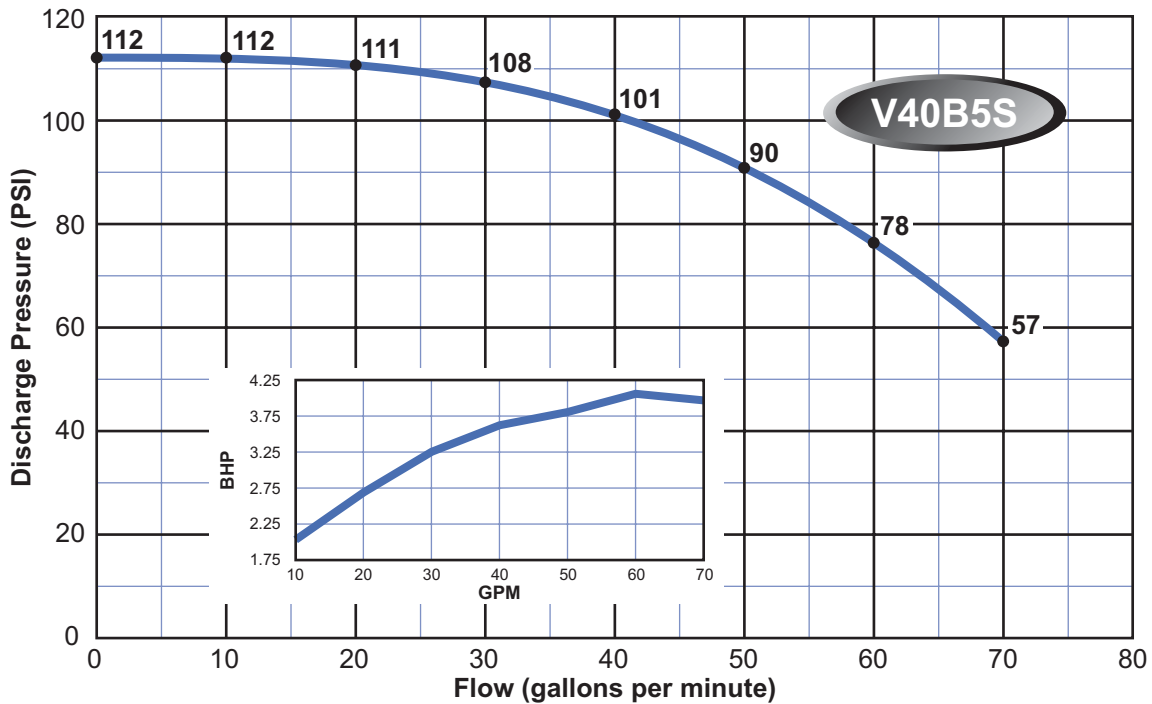
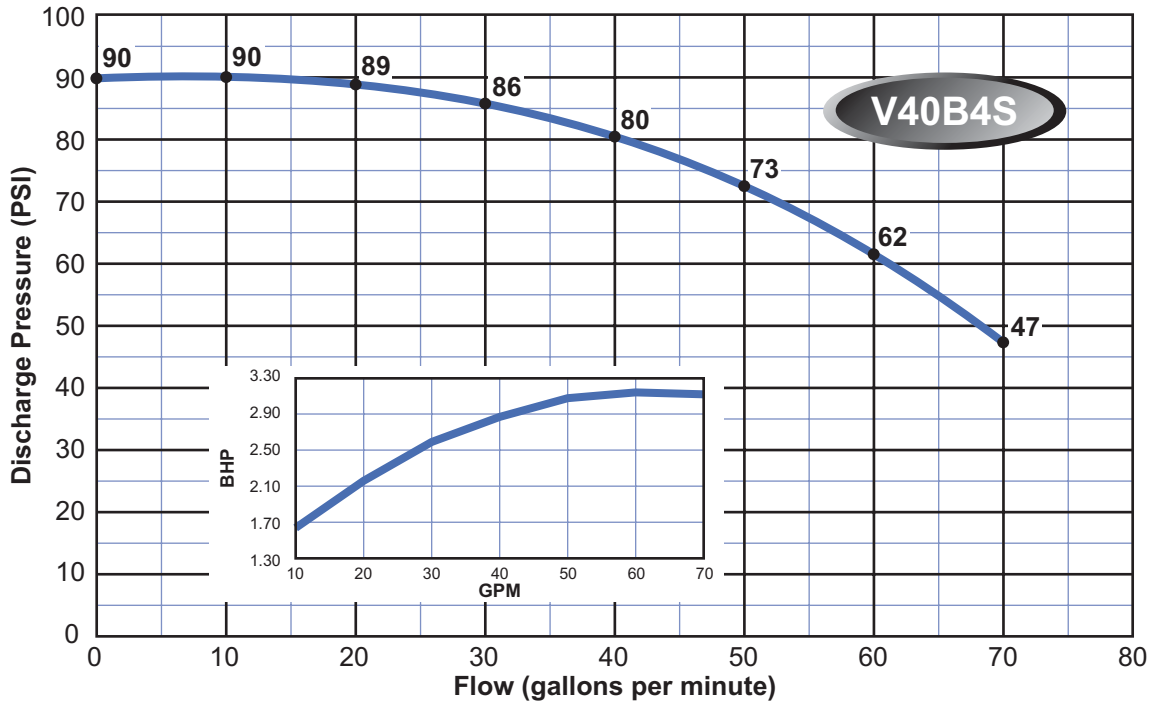

Note:

Curves are based on 60 Hz 3450 rpm motors. 50 Hz 2875 rpm curves are available. These curves are for general guidance only, individual pump curves are available upon request. A certified curve may be requested for an additional cost. Webtrol will build pumps to fit your specific needs, contact factory for pricing.

VERTICAL SERIES BOOSTER - 40 Series

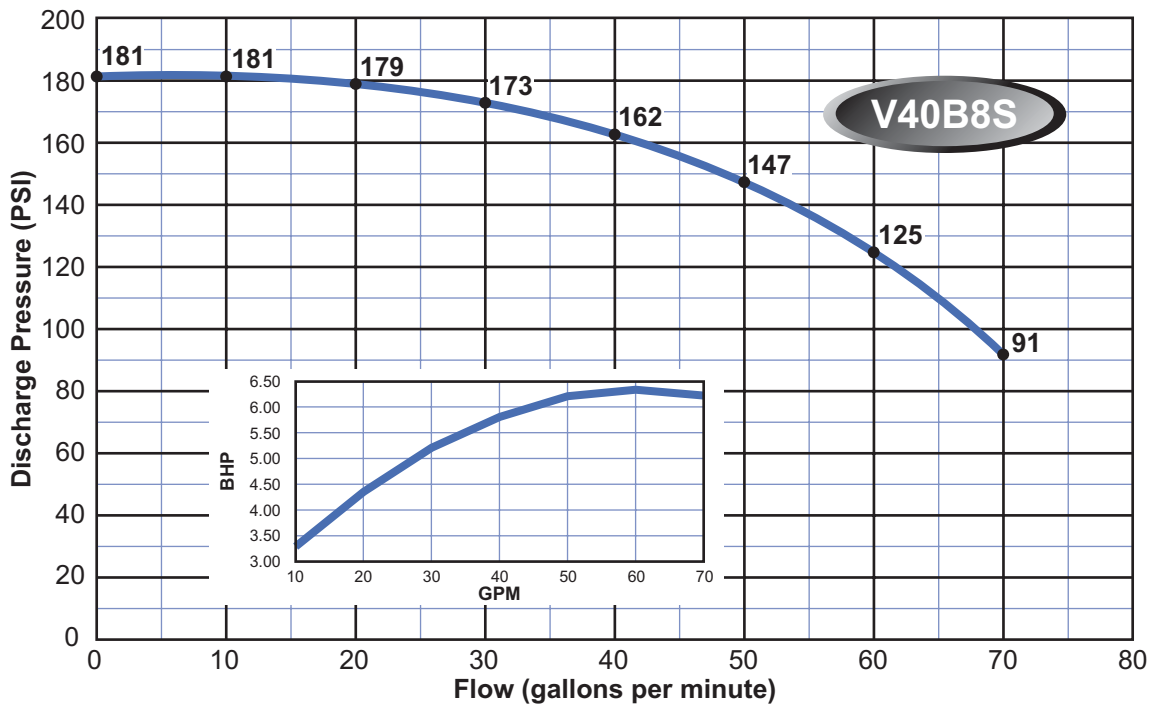
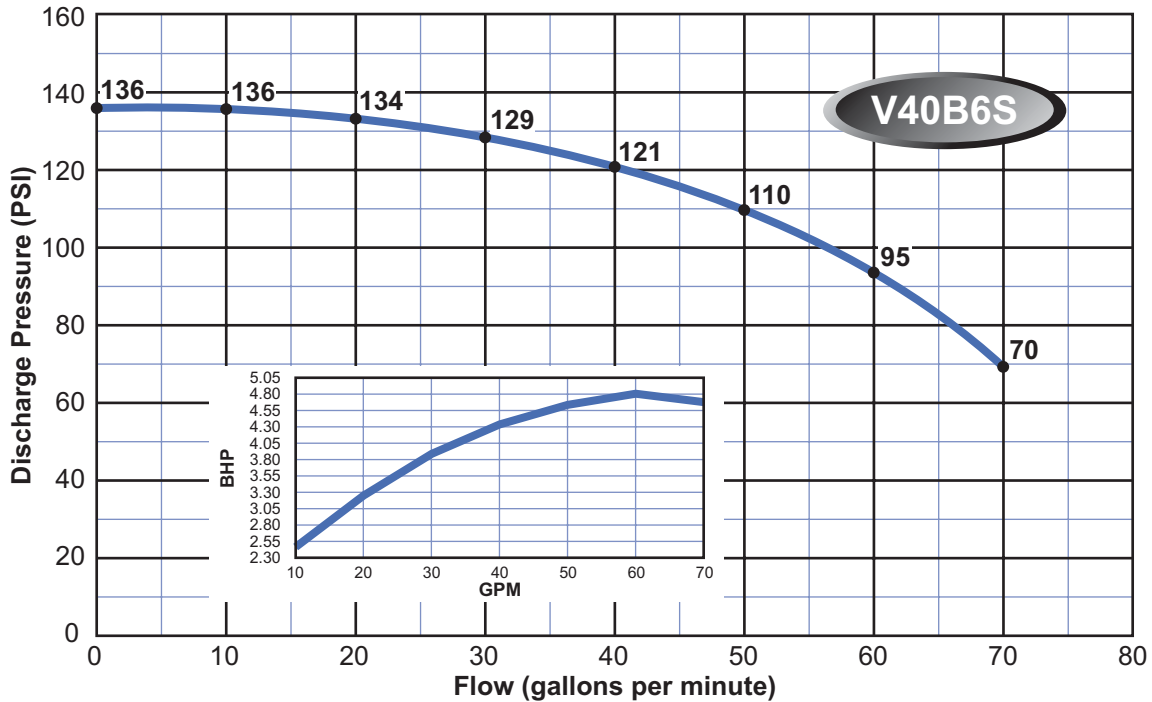

Note:

Curves are based on 60 Hz 3450 rpm motors. 50 Hz 2875 rpm curves are available. These curves are for general guidance only, individual pump curves are available upon request. A certified curve may be requested for an additional cost. Webtrol will build pumps to fit your specific needs, contact factory for pricing.

VERTICAL SERIES BOOSTER - 40 Series

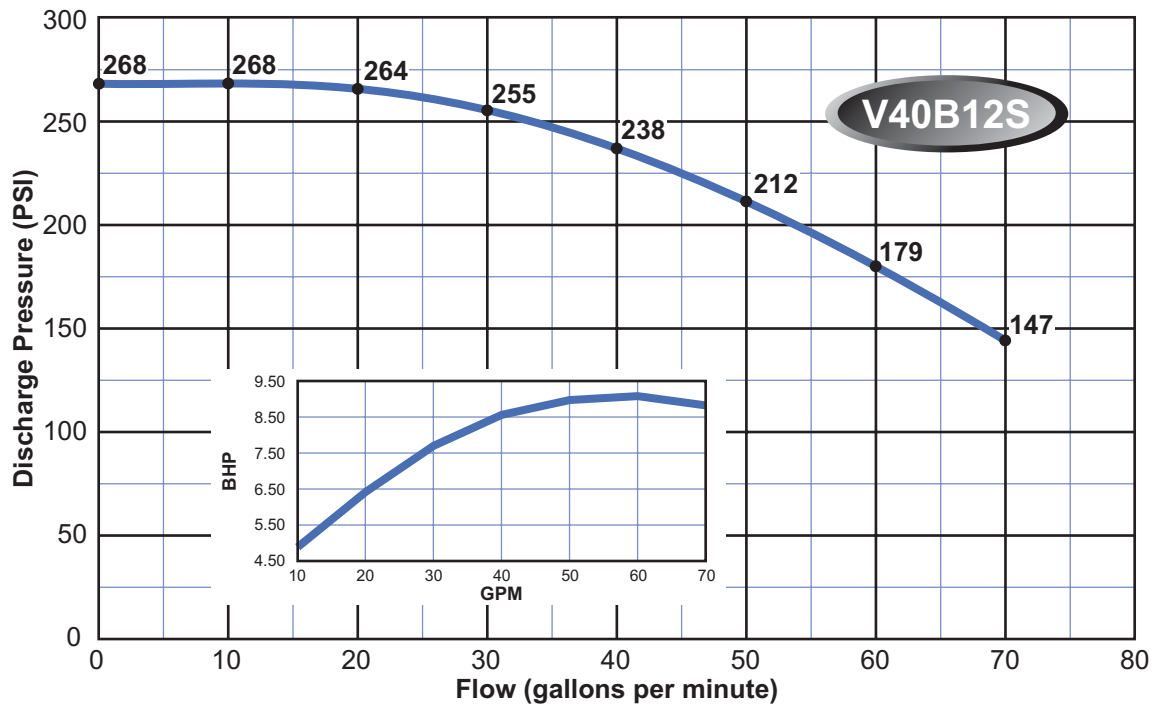
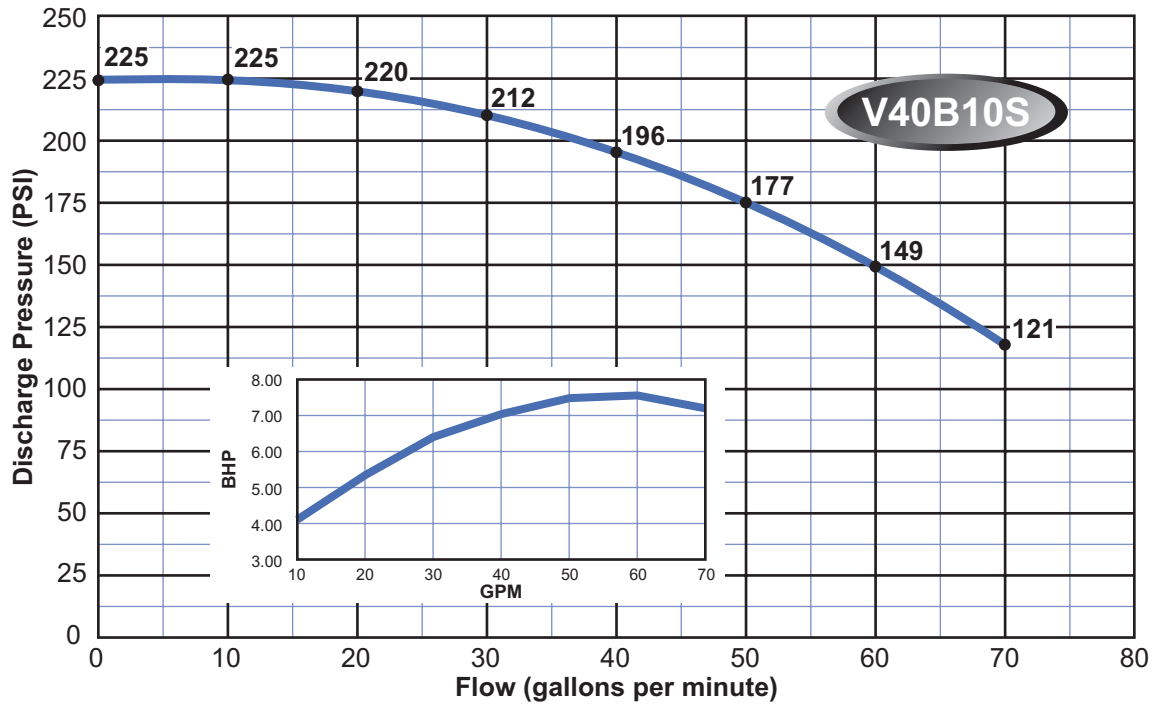

Note:

Curves are based on 60 Hz 3450 rpm motors. 50 Hz 2875 rpm curves are available. These curves are for general guidance only, individual pump curves are available upon request. A certified curve may be requested for an additional cost. Webtrol will build pumps to fit your specific needs, contact factory for pricing.

VERTICAL SERIES BOOSTER - 40 Series

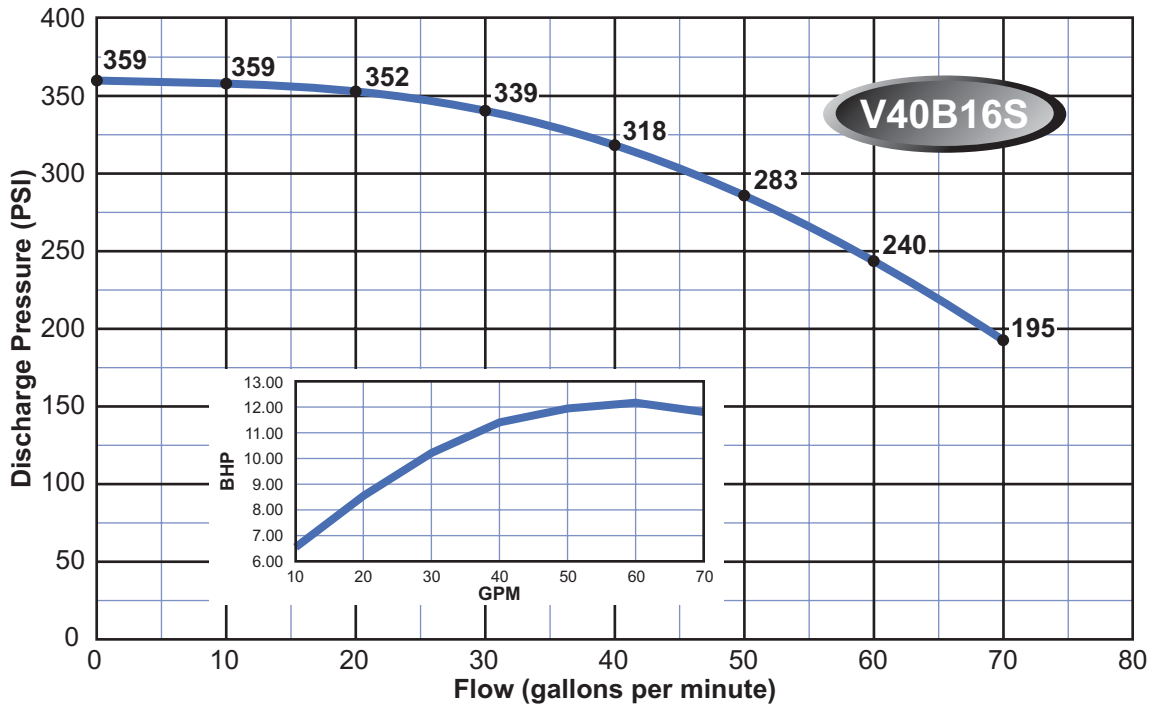
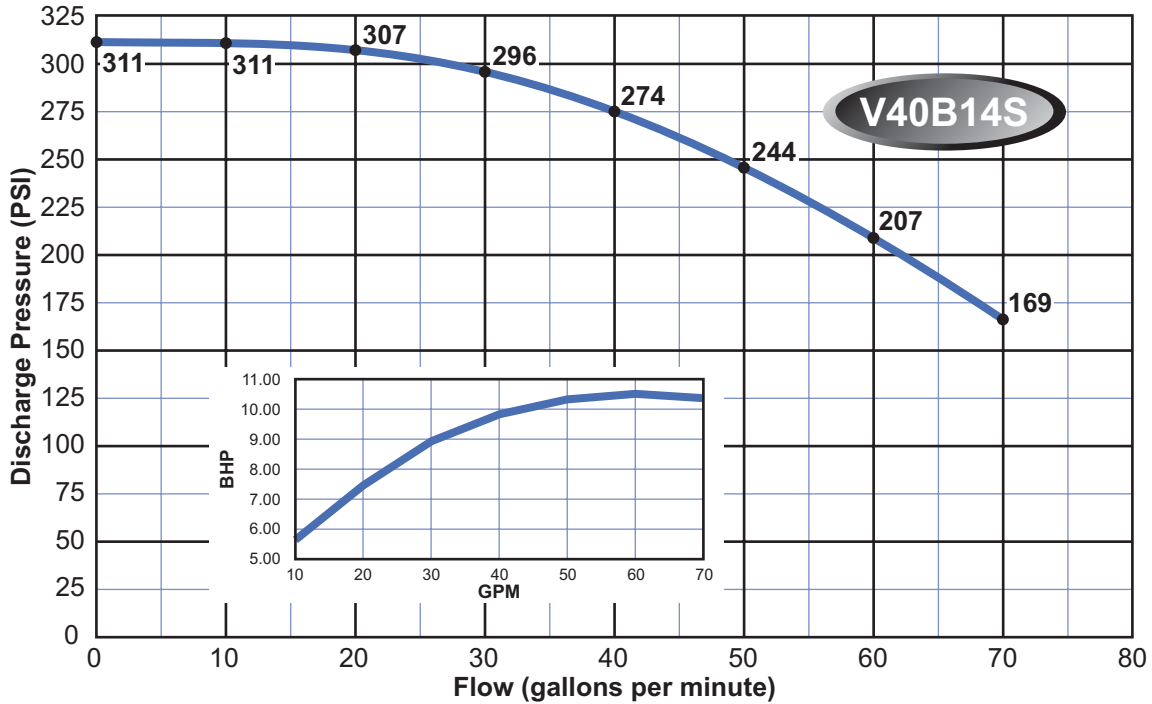

Note:

Curves are based on 60 Hz 3450 rpm motors. 50 Hz 2875 rpm curves are available. These curves are for general guidance only, individual pump curves are available upon request. A certified curve may be requested for an additional cost. Webtrol will build pumps to fit your specific needs, contact factory for pricing.

VERTICAL SERIES BOOSTER - 70 Series

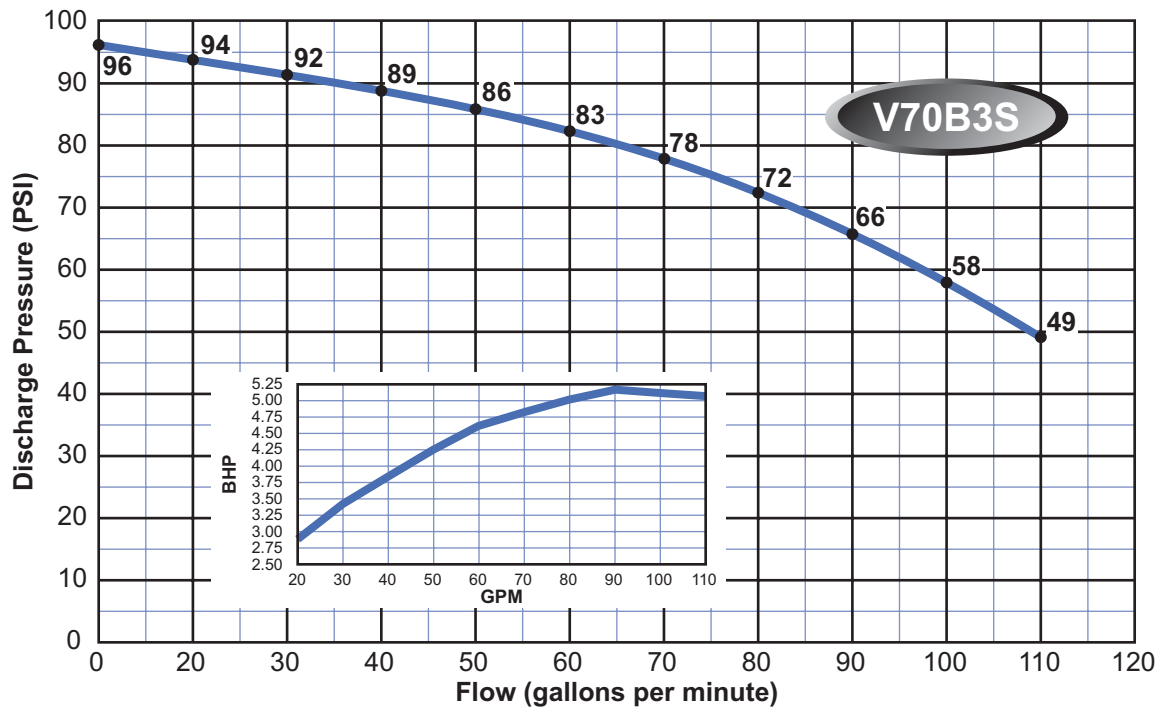
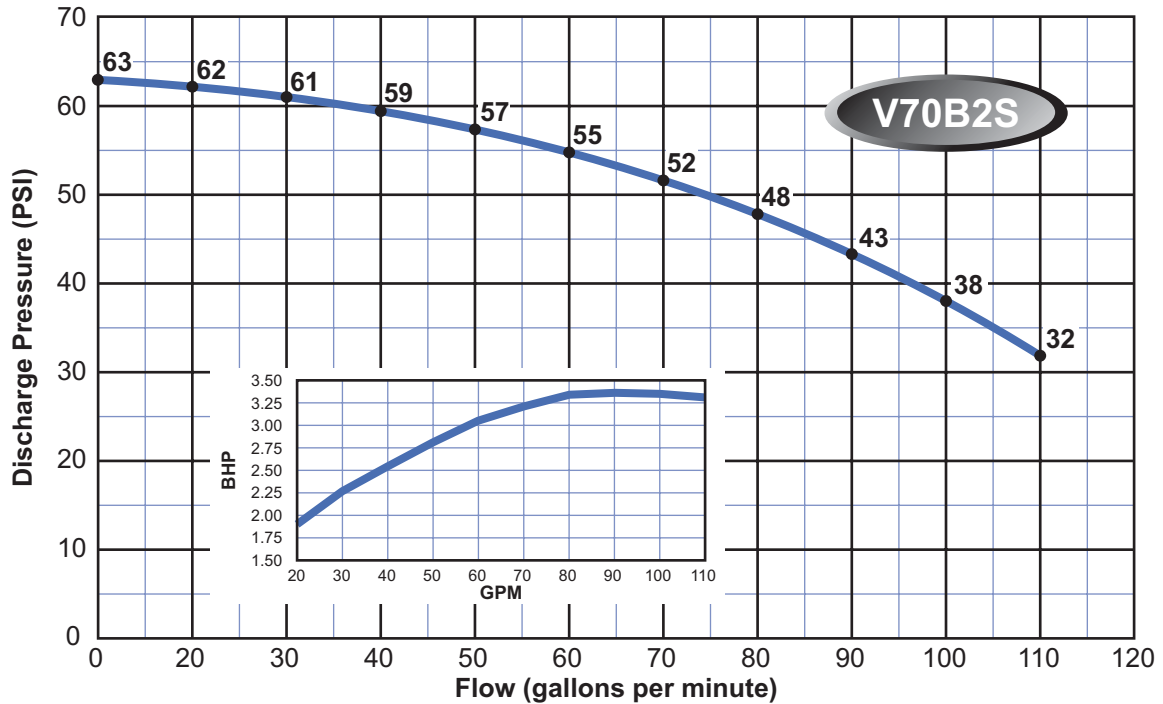

Note:

Curves are based on 60 Hz 3450 rpm motors. 50 Hz 2875 rpm curves are available. These curves are for general guidance only, individual pump curves are available upon request. A certified curve may be requested for an additional cost. Webtrol will build pumps to fit your specific needs, contact factory for pricing.

VERTICAL SERIES BOOSTER - 70 Series

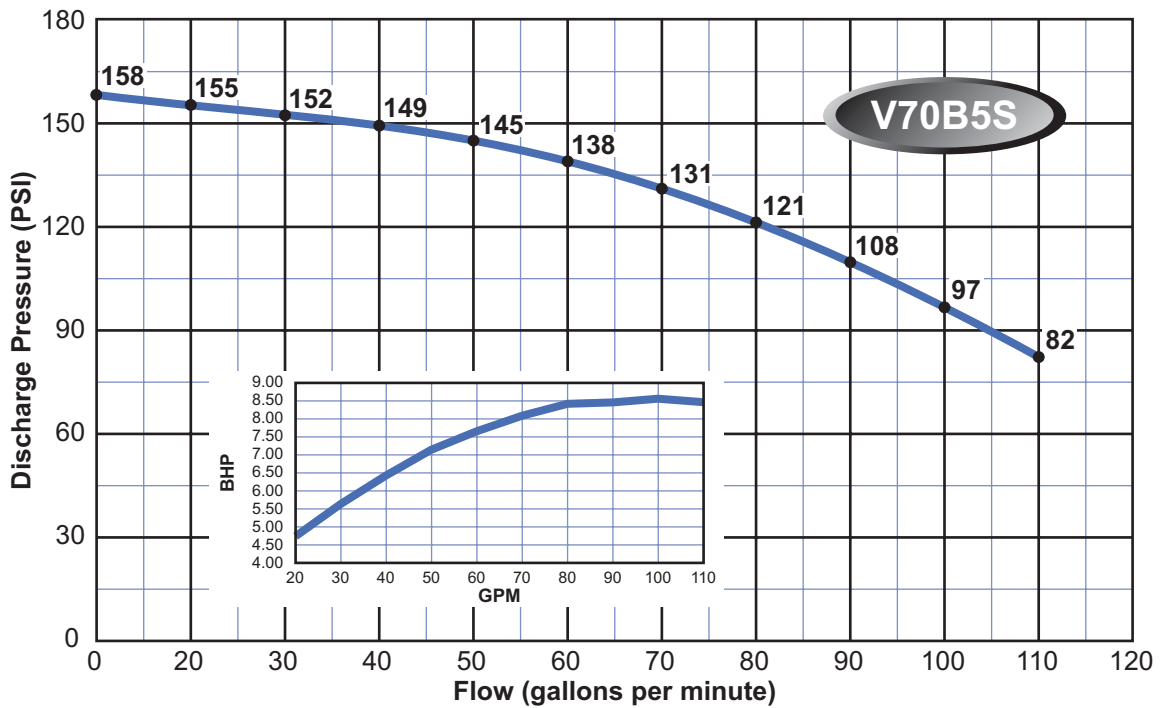
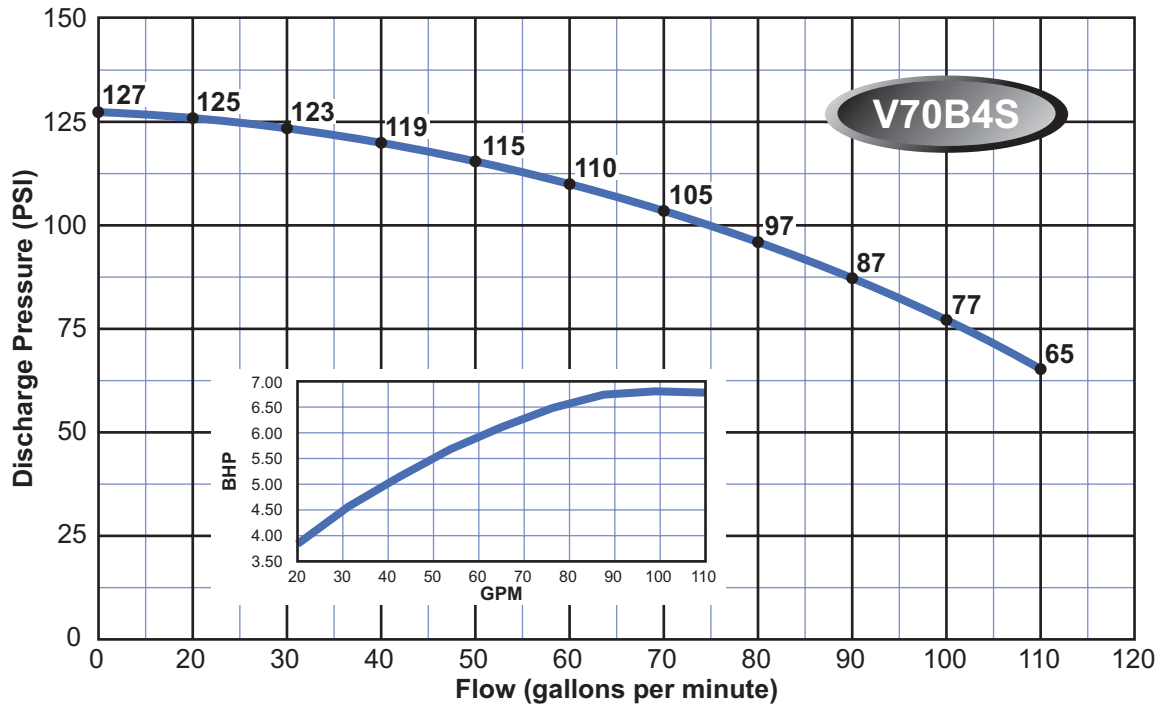

Note:

Curves are based on 60 Hz 3450 rpm motors. 50 Hz 2875 rpm curves are available. These curves are for general guidance only, individual pump curves are available upon request. A certified curve may be requested for an additional cost. Webtrol will build pumps to fit your specific needs, contact factory for pricing.

VERTICAL SERIES BOOSTER - 70 Series

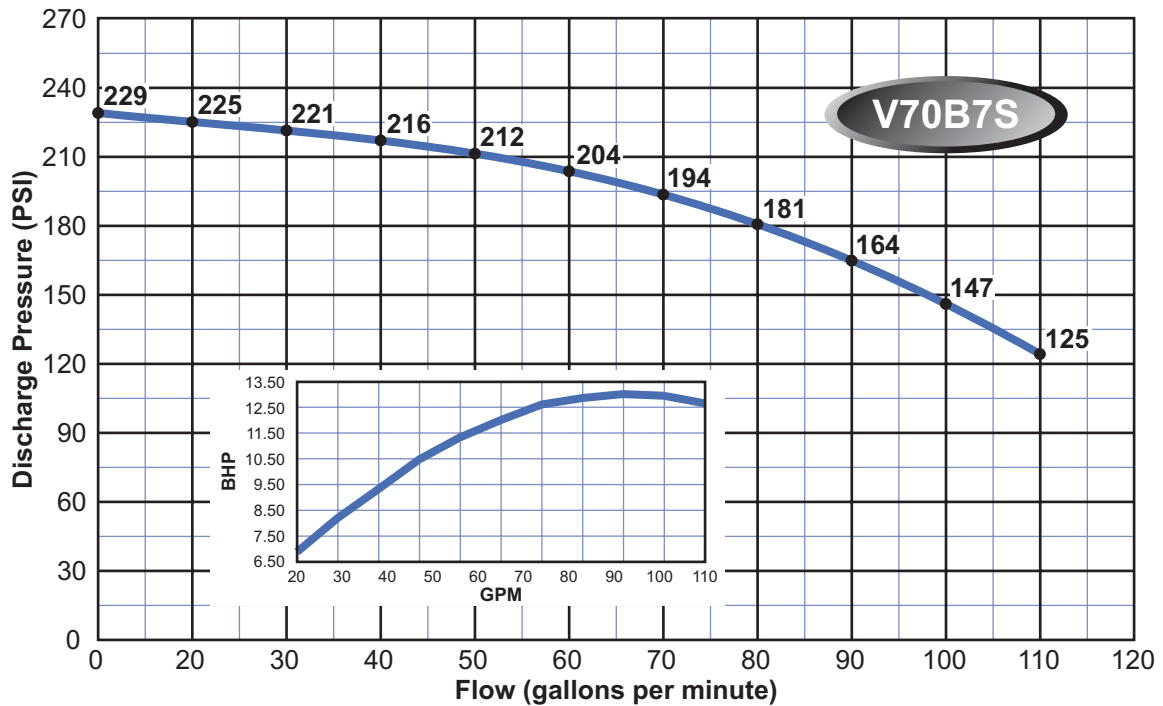
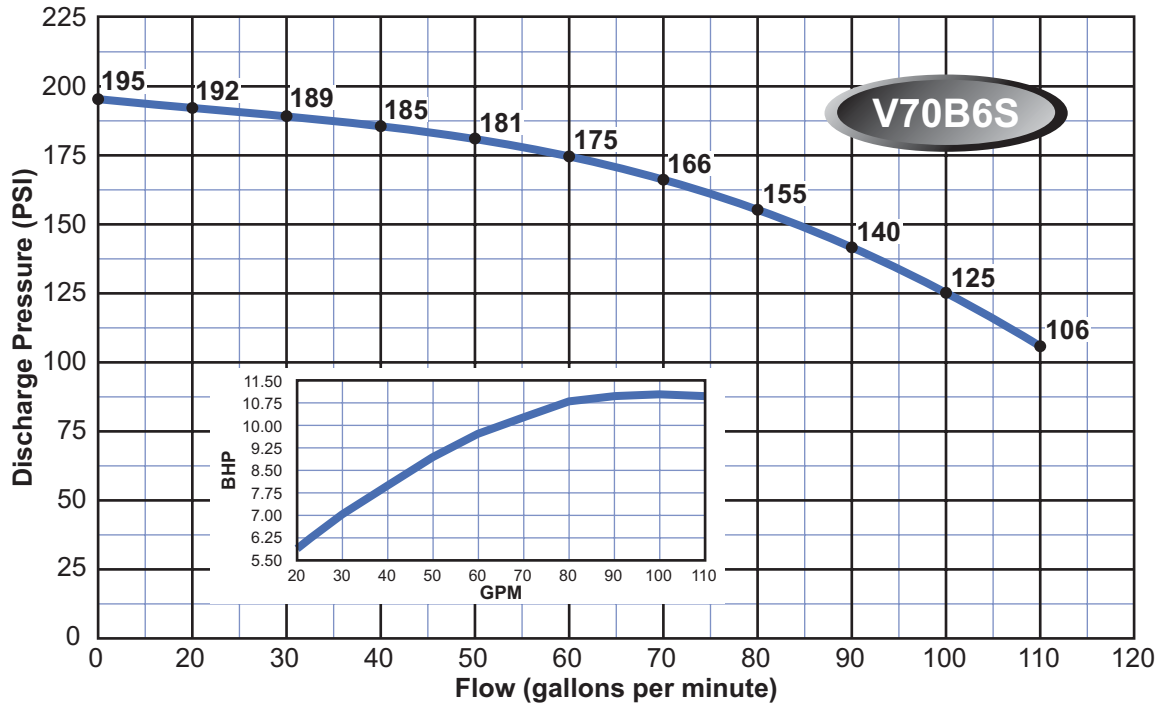

Note:

Curves are based on 60 Hz 3450 rpm motors. 50 Hz 2875 rpm curves are available. These curves are for general guidance only, individual pump curves are available upon request. A certified curve may be requested for an additional cost. Webtrol will build pumps to fit your specific needs, contact factory for pricing.

VERTICAL SERIES BOOSTER - 70 Series

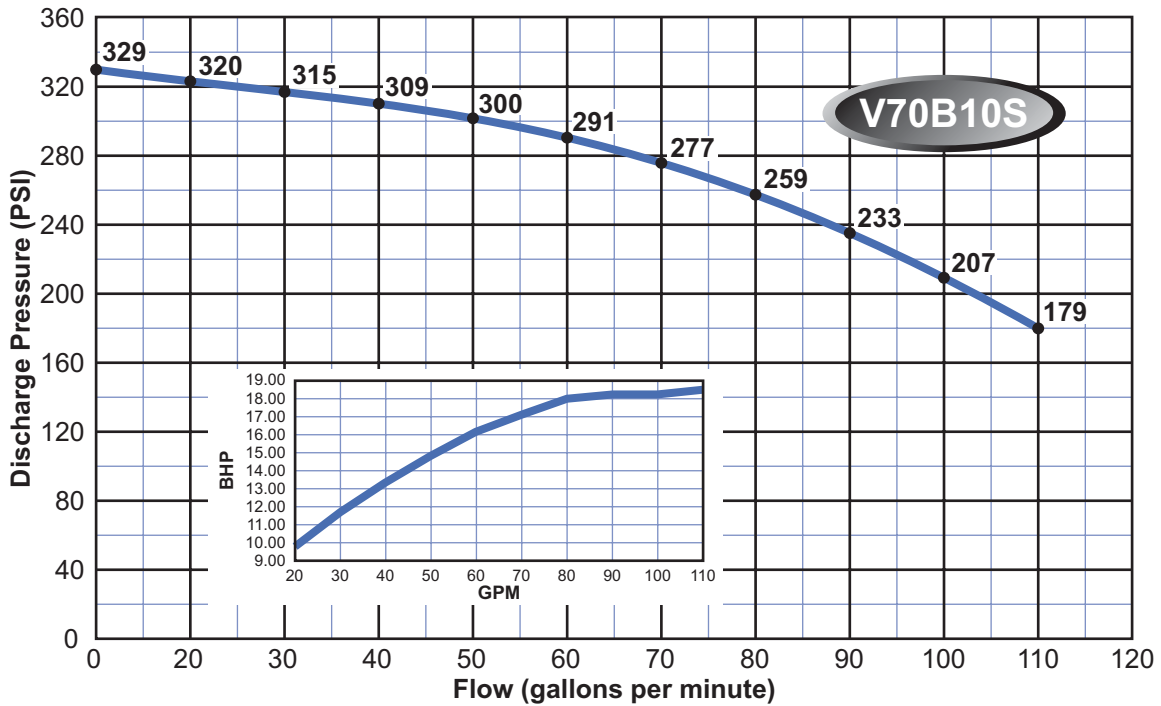
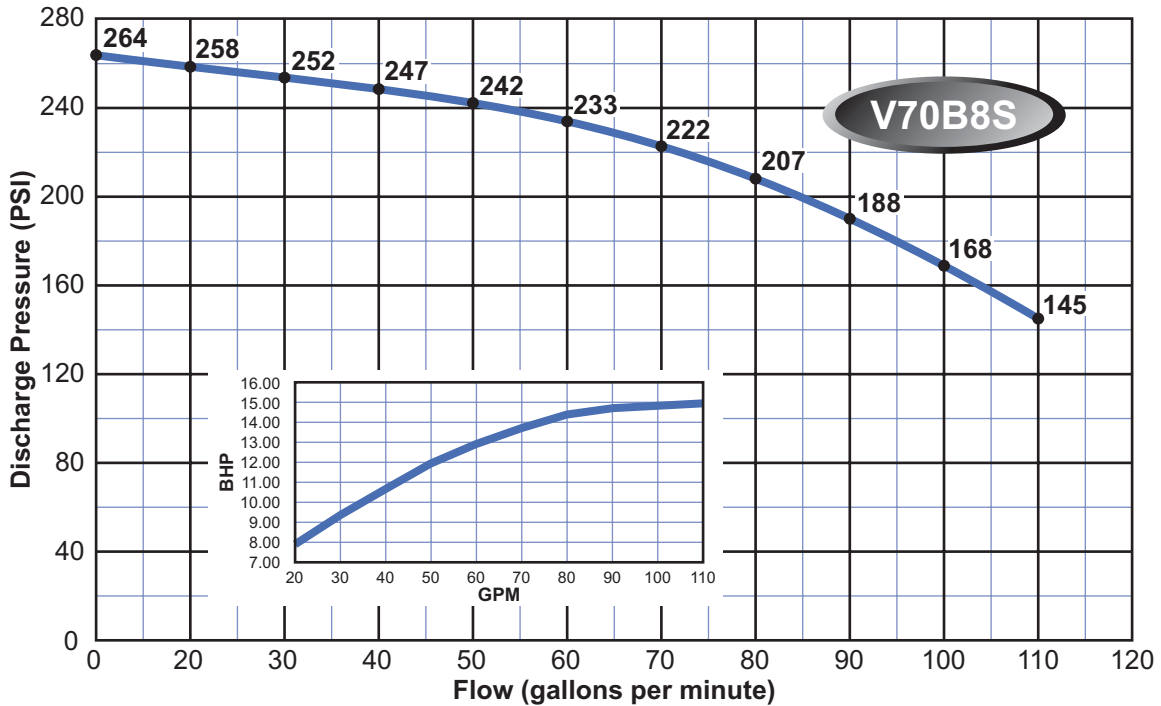

Note:

Curves are based on 60 Hz 3450 rpm motors. 50 Hz 2875 rpm curves are available. These curves are for general guidance only, individual pump curves are available upon request. A certified curve may be requested for an additional cost. Webtrol will build pumps to fit your specific needs, contact factory for pricing.

VERTICAL SERIES BOOSTER - 70 Series

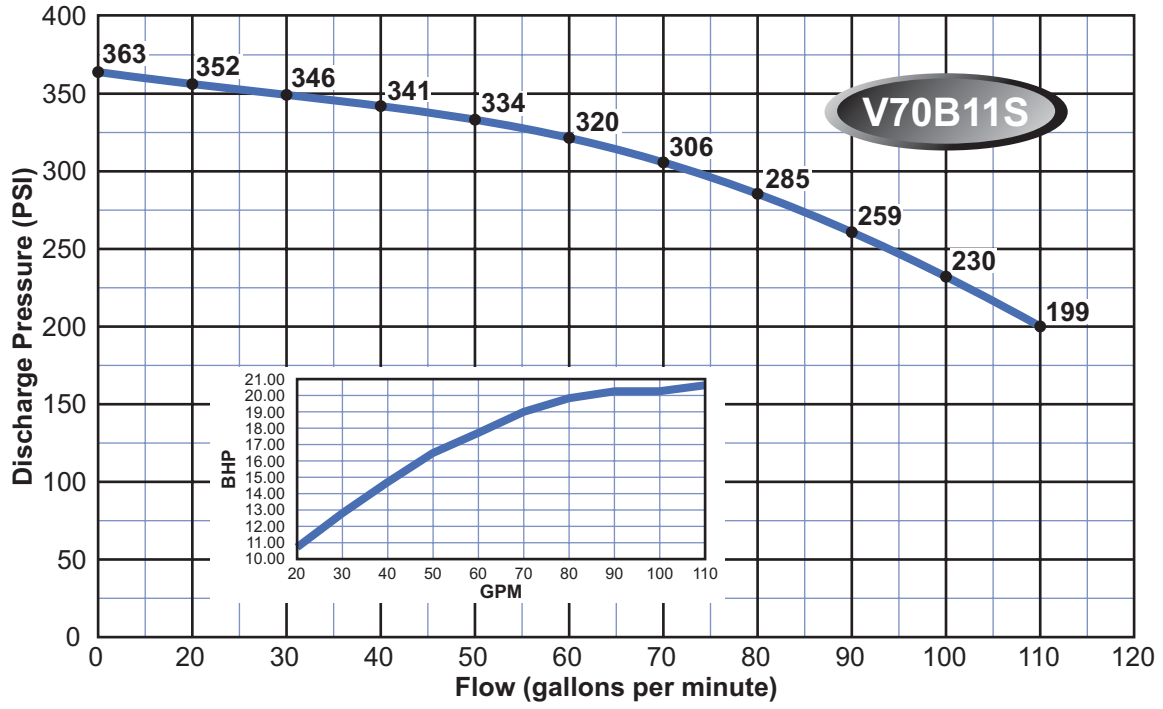

Note:

Curves are based on 60 Hz 3450 rpm motors. 50 Hz 2875 rpm curves are available. These curves are for general guidance only, individual pump curves are available upon request. A certified curve may be requested for an additional cost. Webtrol will build pumps to fit your specific needs, contact factory for pricing.

VERTICAL SERIES BOOSTER - 140 Series

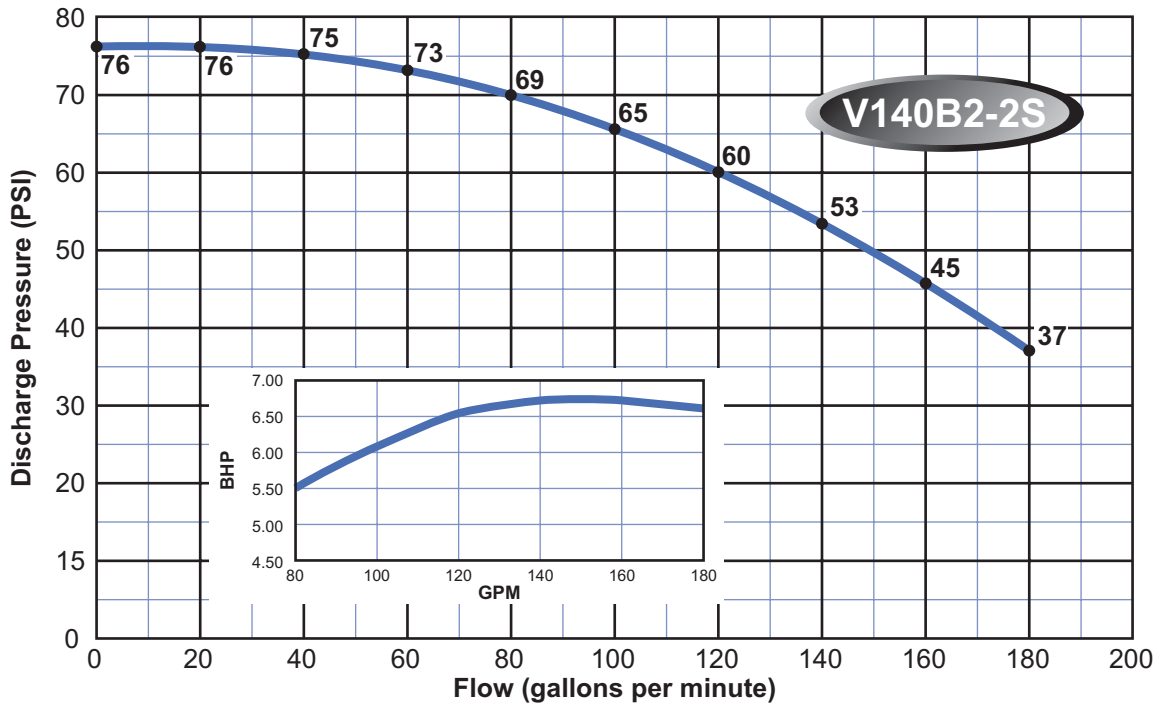
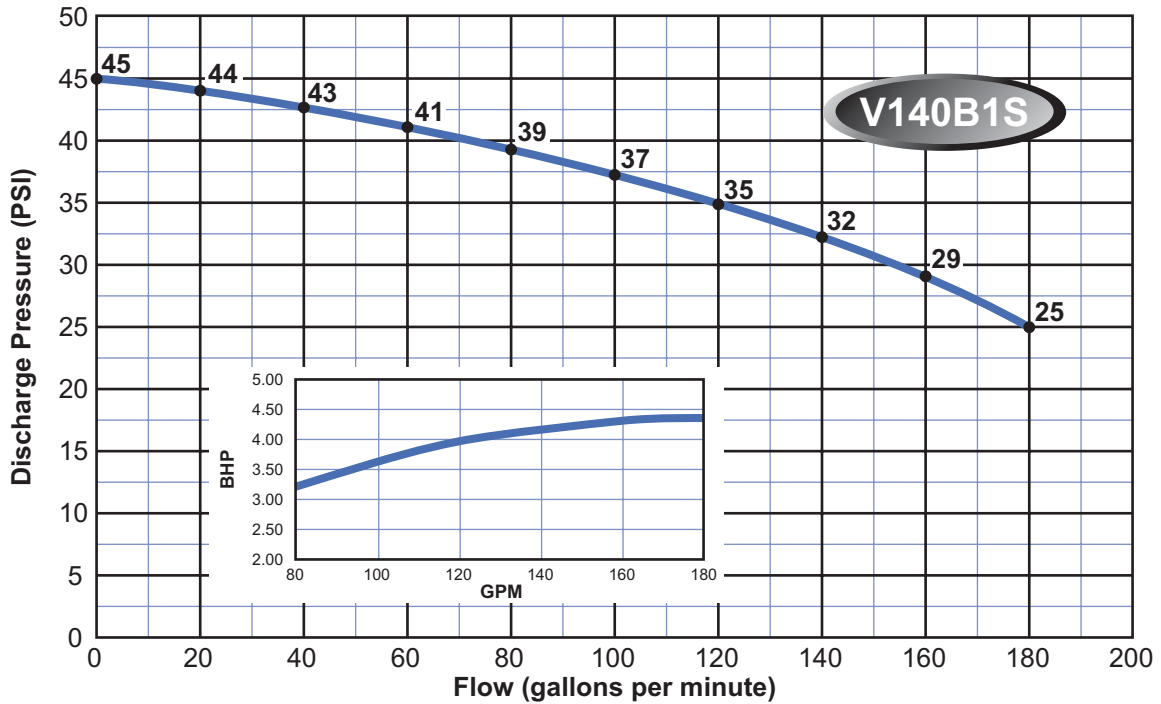

Note:

Curves are based on 60 Hz 3450 rpm motors. 50 Hz 2875 rpm curves are available. These curves are for general guidance only, individual pump curves are available upon request. A certified curve may be requested for an additional cost. Webtrol will build pumps to fit your specific needs, contact factory for pricing.

VERTICAL SERIES BOOSTER - 140 Series

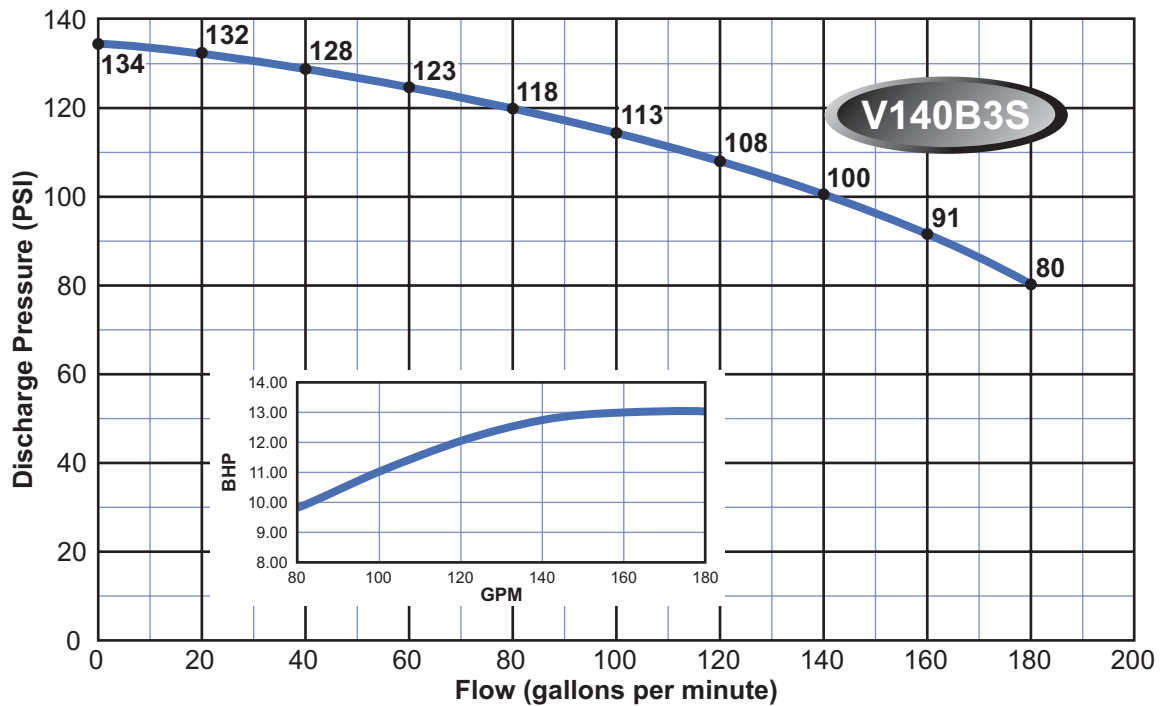
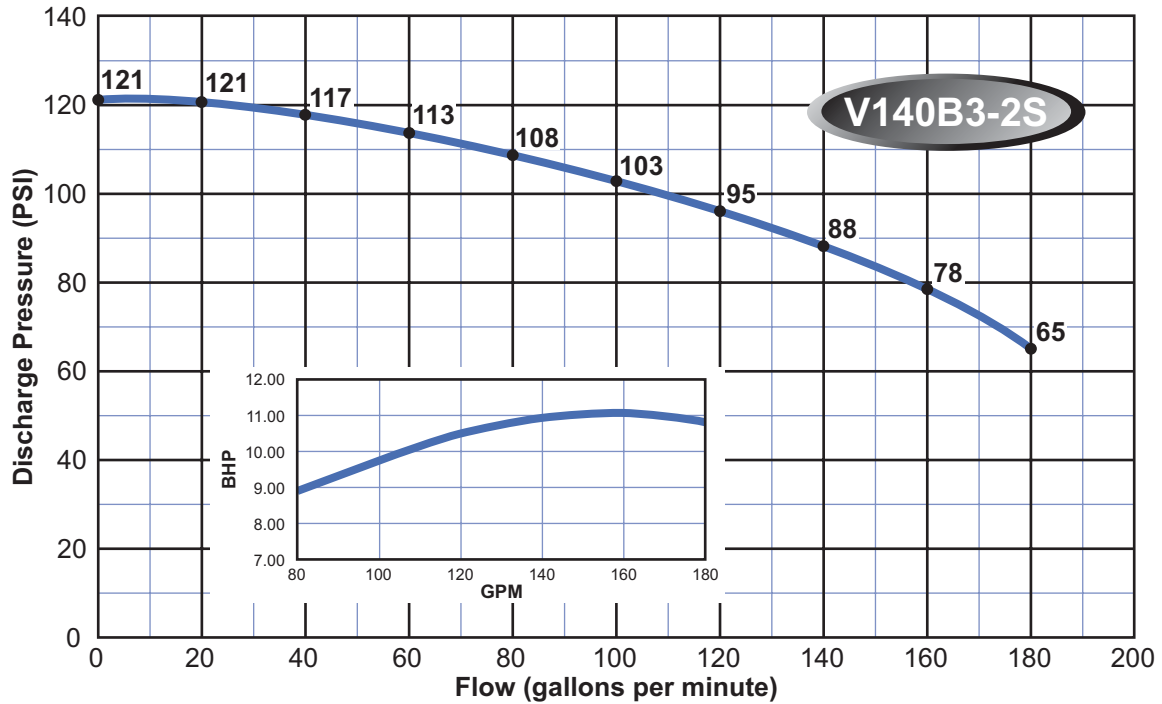

Note:

Curves are based on 60 Hz 3450 rpm motors. 50 Hz 2875 rpm curves are available. These curves are for general guidance only, individual pump curves are available upon request. A certified curve may be requested for an additional cost. Webtrol will build pumps to fit your specific needs, contact factory for pricing.

VERTICAL SERIES BOOSTER - 140 Series

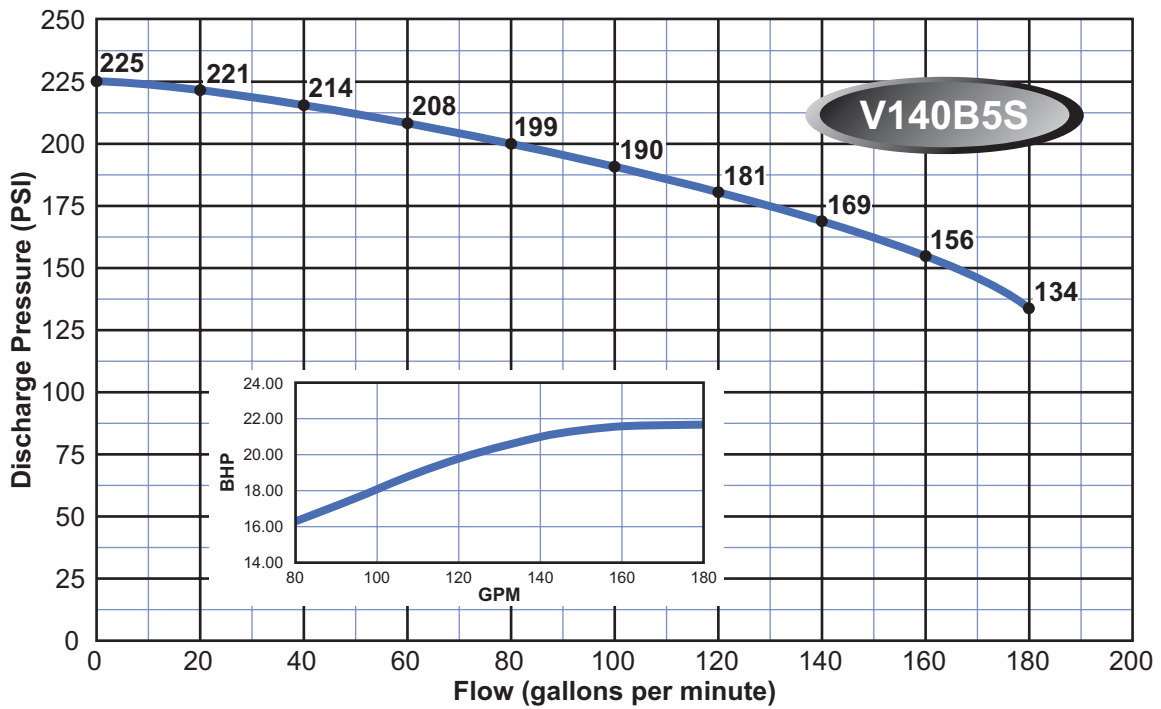
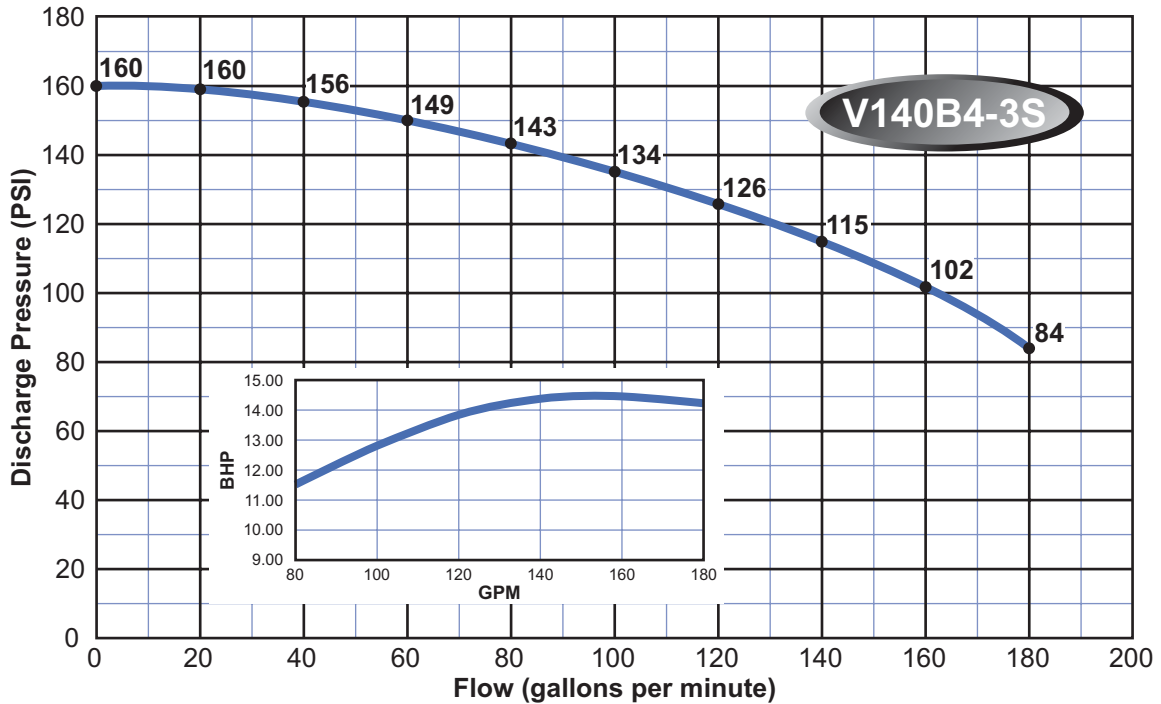

Note:

Curves are based on 60 Hz 3450 rpm motors. 50 Hz 2875 rpm curves are available. These curves are for general guidance only, individual pump curves are available upon request. A certified curve may be requested for an additional cost. Webtrol will build pumps to fit your specific needs, contact factory for pricing.

VERTICAL SERIES BOOSTER - 140 Series

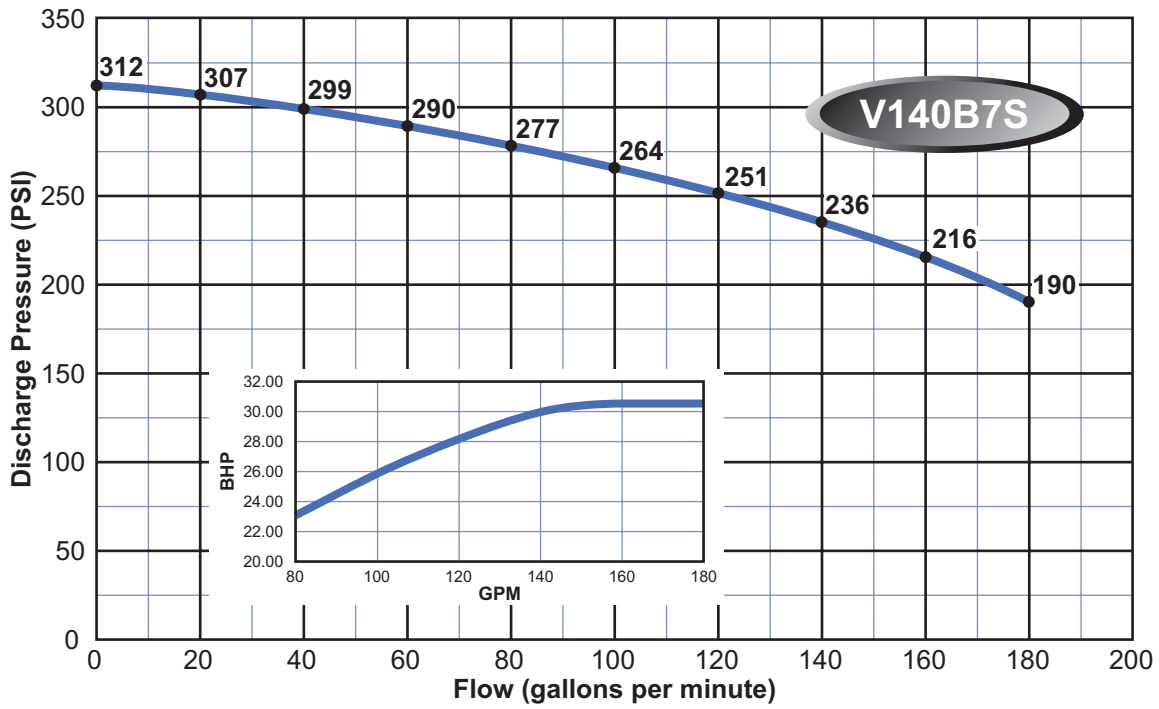
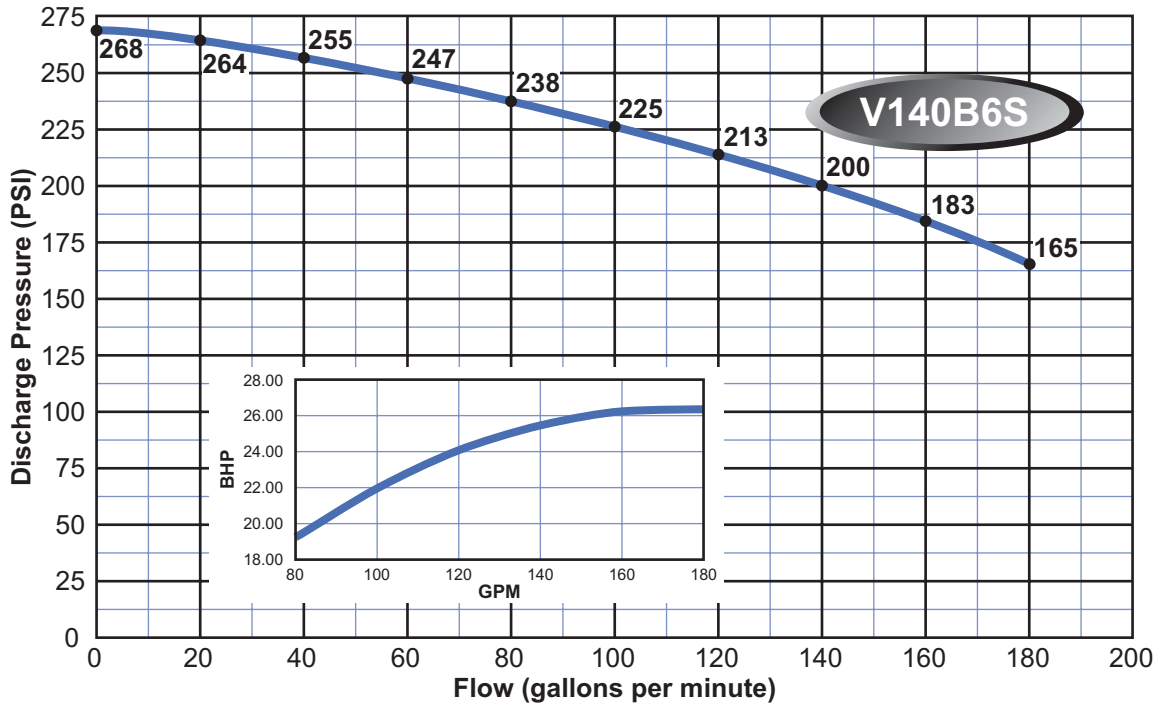

Note:

Curves are based on 60 Hz 3450 rpm motors. 50 Hz 2875 rpm curves are available. These curves are for general guidance only, individual pump curves are available upon request. A certified curve may be requested for an additional cost. Webtrol will build pumps to fit your specific needs, contact factory for pricing.

VERTICAL SERIES BOOSTER - 140 Series

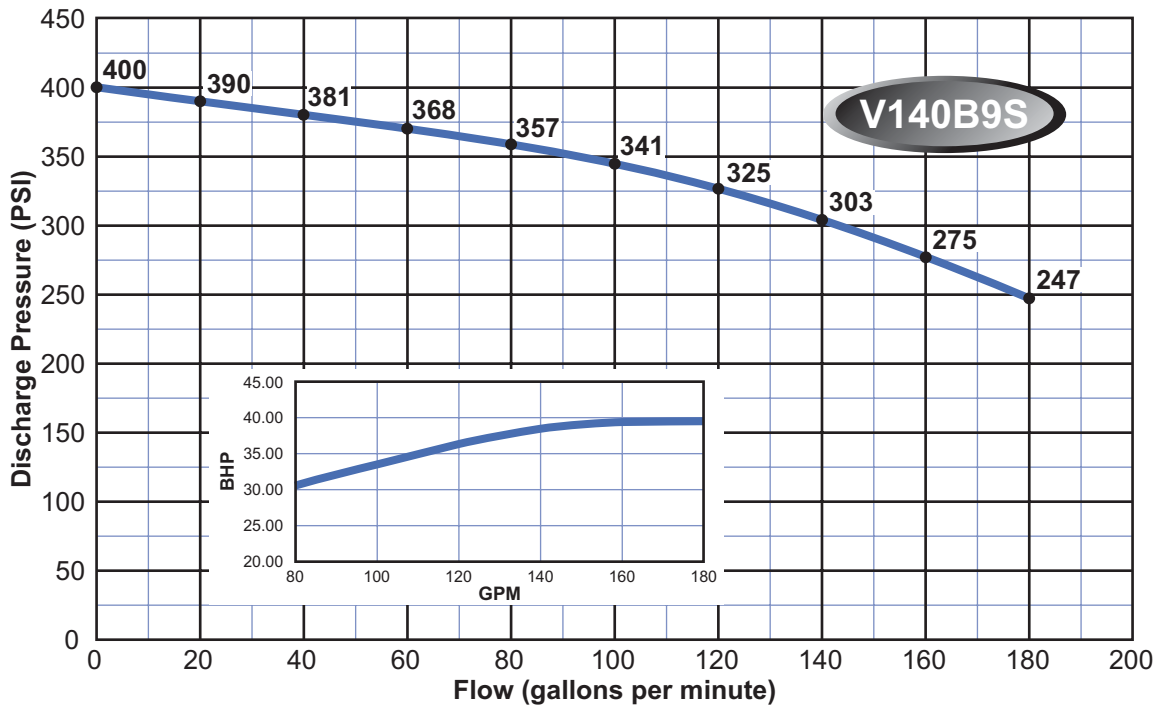
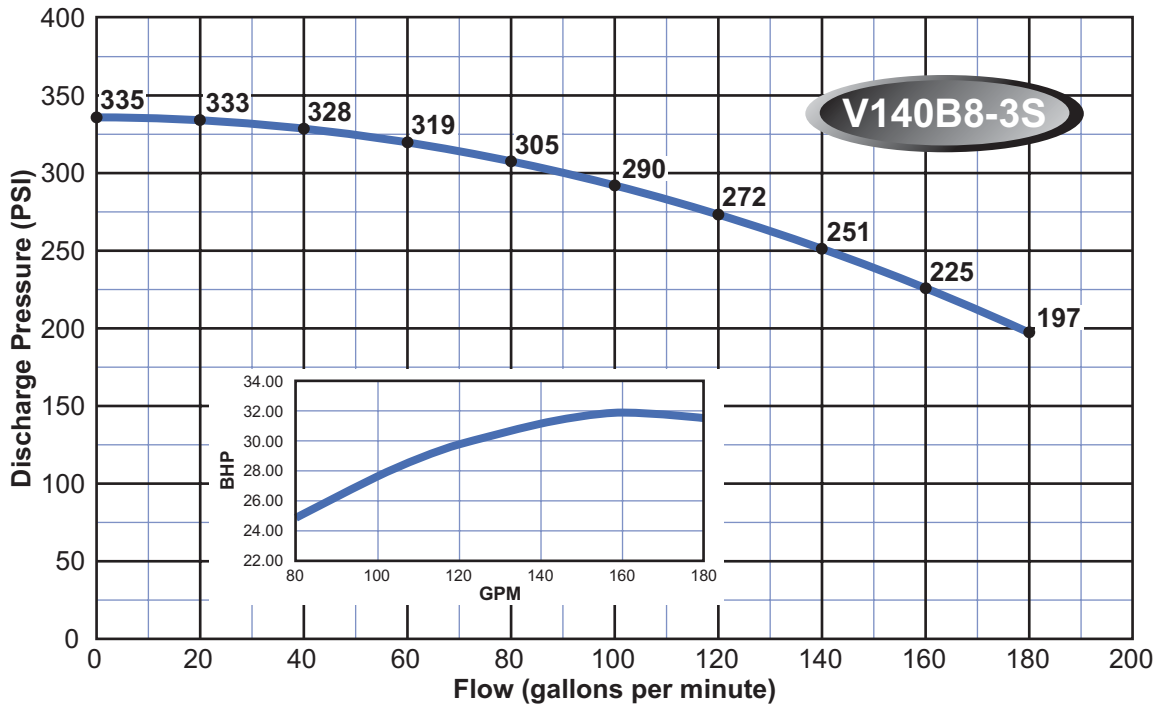

Note:

Curves are based on 60 Hz 3450 rpm motors. 50 Hz 2875 rpm curves are available. These curves are for general guidance only, individual pump curves are available upon request. A certified curve may be requested for an additional cost. Webtrol will build pumps to fit your specific needs, contact factory for pricing.

VERTICAL SERIES BOOSTER - 140 Series

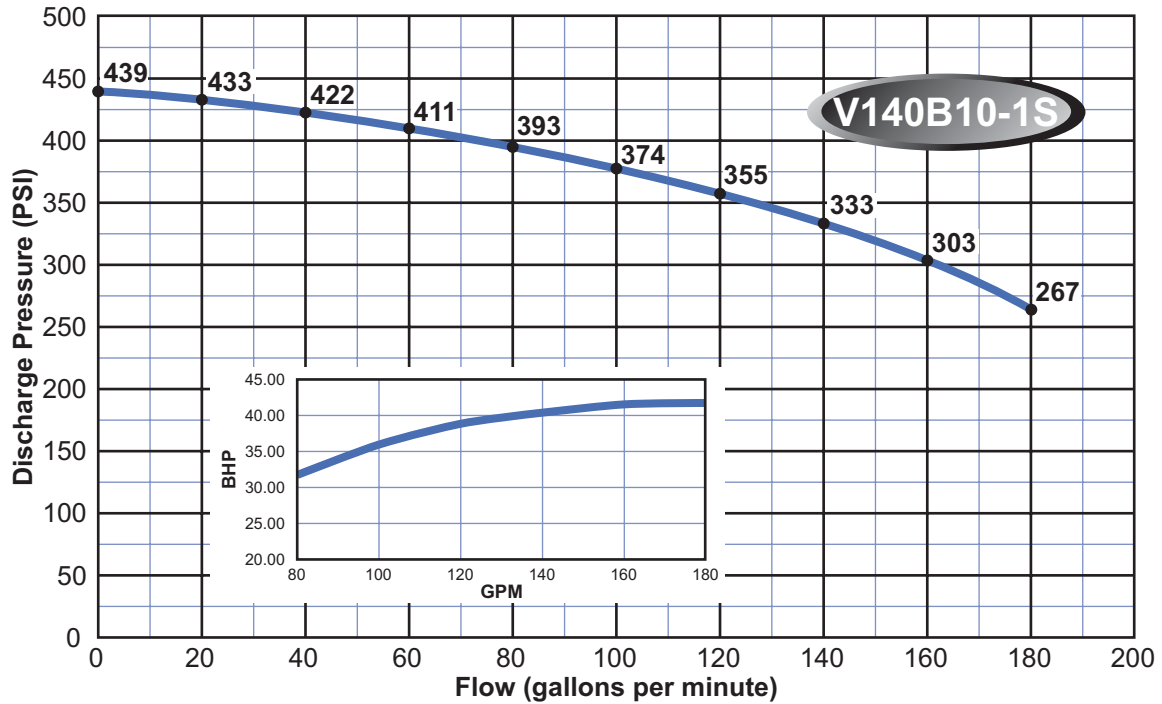

Note:

Curves are based on 60 Hz 3450 rpm motors. 50 Hz 2875 rpm curves are available. These curves are for general guidance only, individual pump curves are available upon request. A certified curve may be requested for an additional cost. Webtrol will build pumps to fit your specific needs, contact factory for pricing.

VERTICAL SERIES BOOSTER - 200 Series

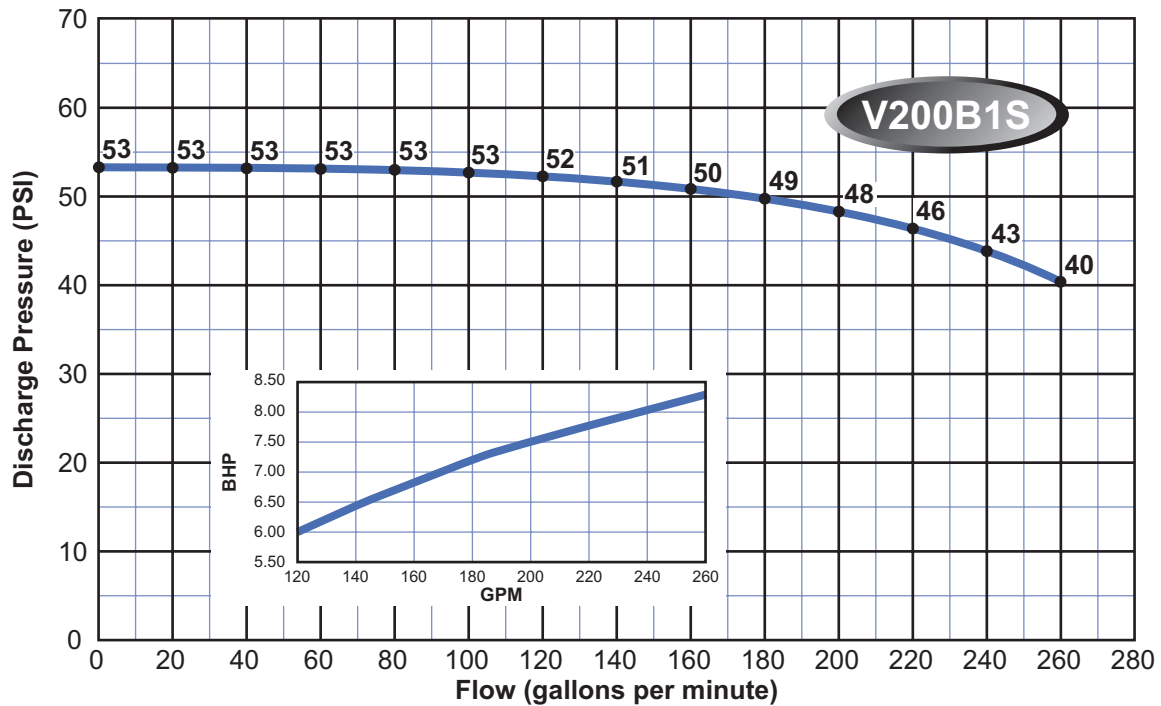
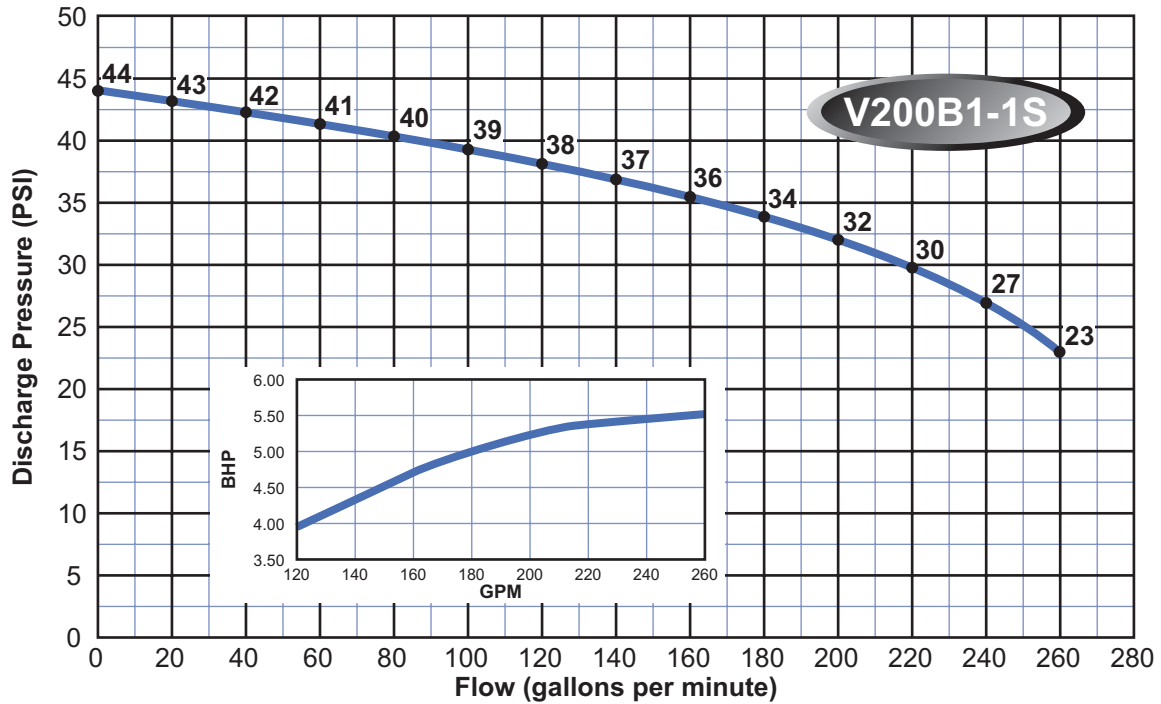

Note:

Curves are based on 60 Hz 3450 rpm motors. 50 Hz 2875 rpm curves are available. These curves are for general guidance only, individual pump curves are available upon request. A certified curve may be requested for an additional cost. Webtrol will build pumps to fit your specific needs, contact factory for pricing.

VERTICAL SERIES BOOSTER - 200 Series

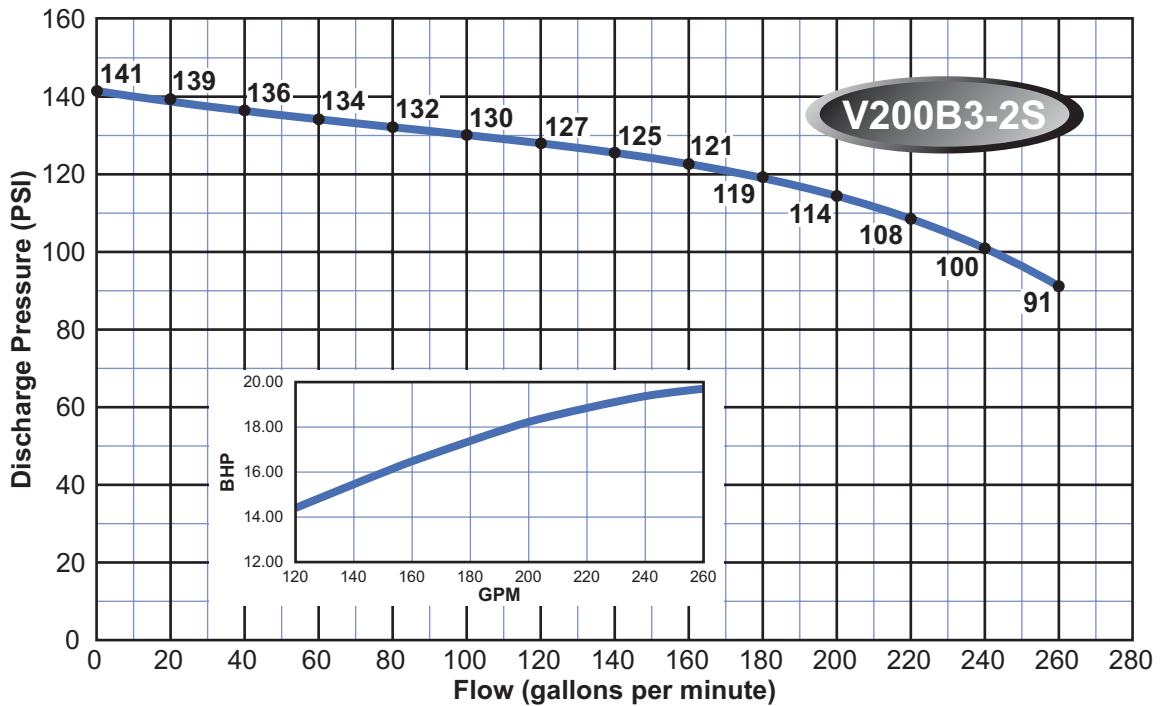
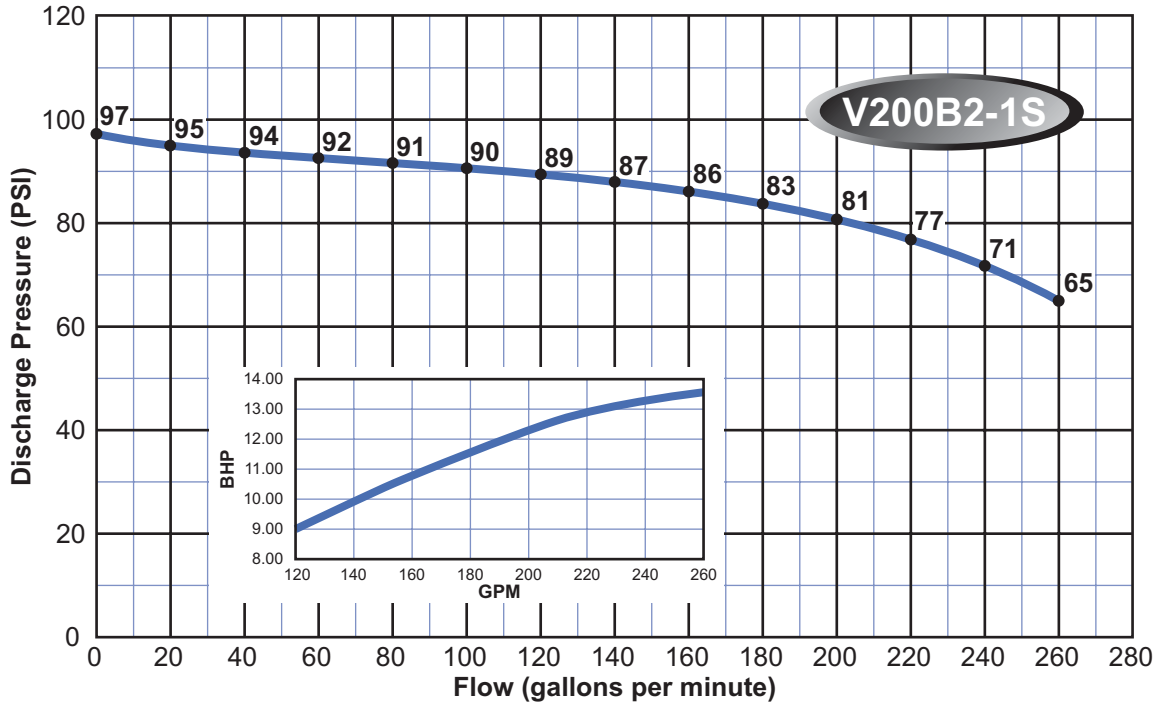

Note:

Curves are based on 60 Hz 3450 rpm motors. 50 Hz 2875 rpm curves are available. These curves are for general guidance only, individual pump curves are available upon request. A certified curve may be requested for an additional cost. Webtrol will build pumps to fit your specific needs, contact factory for pricing.

VERTICAL SERIES BOOSTER - 200 Series

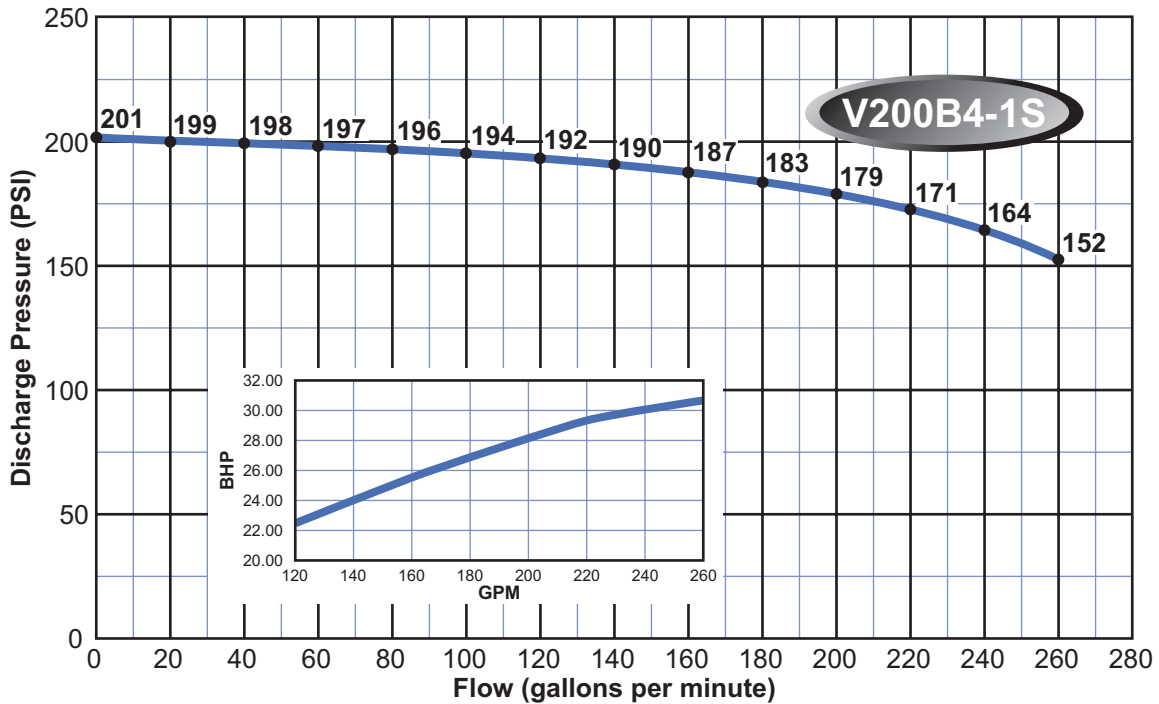
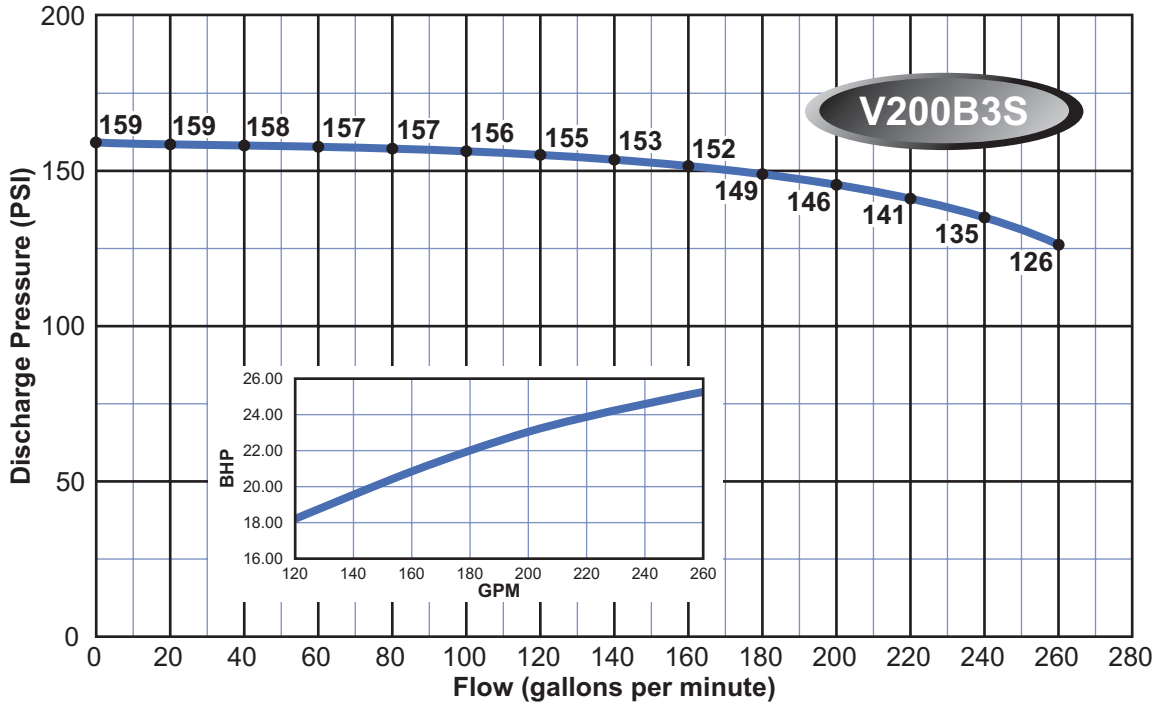

Note:

Curves are based on 60 Hz 3450 rpm motors. 50 Hz 2875 rpm curves are available. These curves are for general guidance only, individual pump curves are available upon request. A certified curve may be requested for an additional cost. Webtrol will build pumps to fit your specific needs, contact factory for pricing.

VERTICAL SERIES BOOSTER - 200 Series

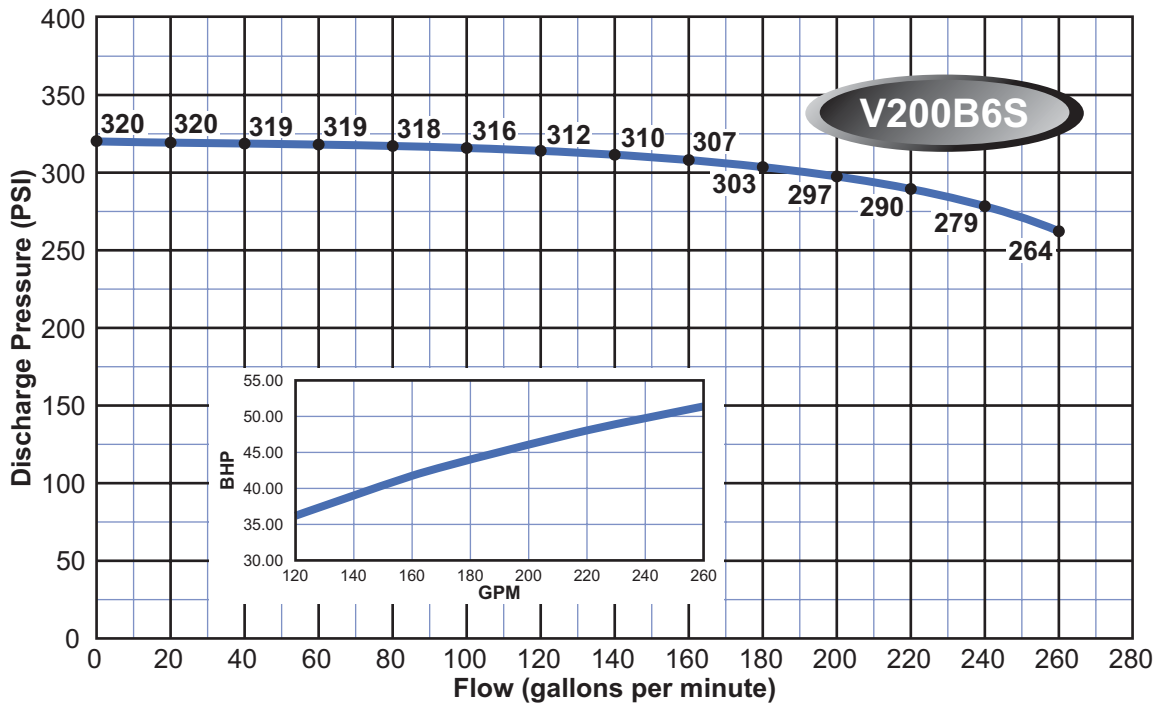
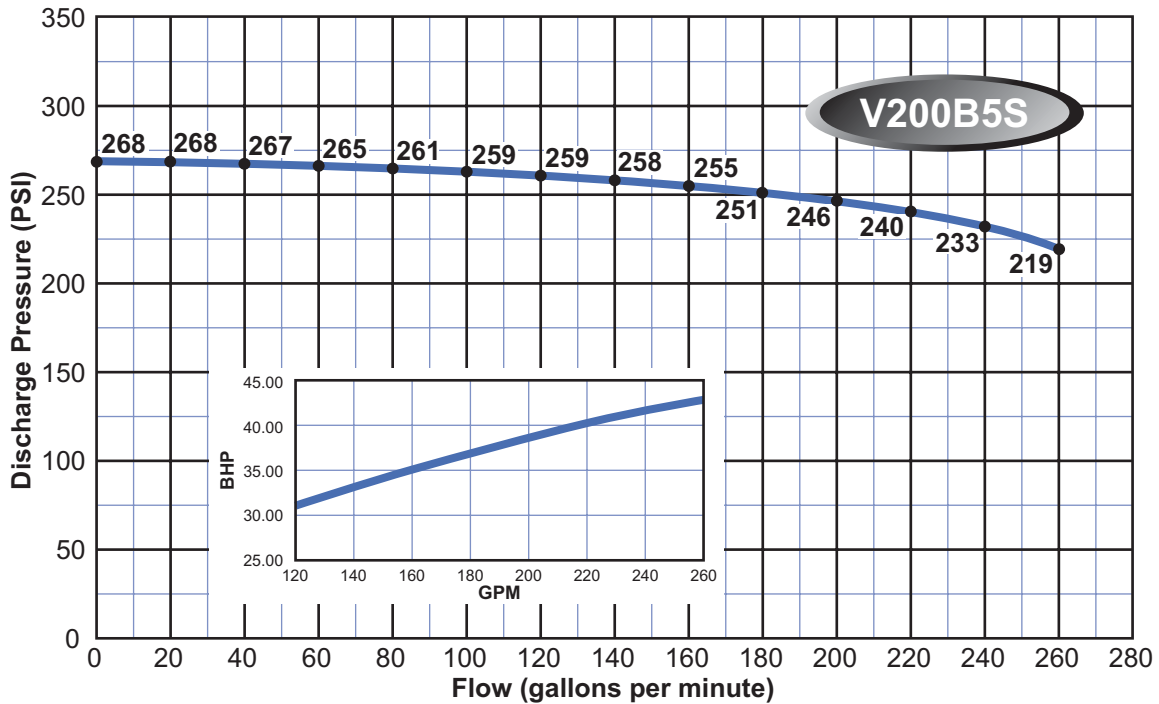

Note:

Curves are based on 60 Hz 3450 rpm motors. 50 Hz 2875 rpm curves are available. These curves are for general guidance only, individual pump curves are available upon request. A certified curve may be requested for an additional cost. Webtrol will build pumps to fit your specific needs, contact factory for pricing.

VERTICAL SERIES BOOSTER - 200 Series

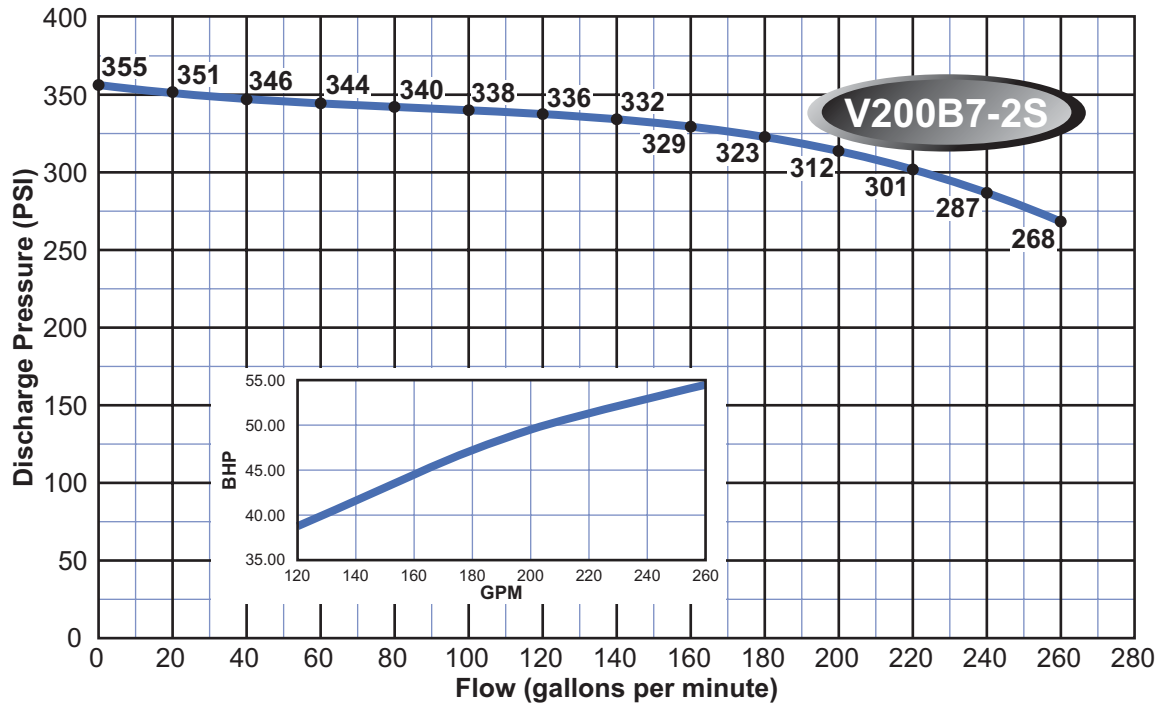

Note:

Curves are based on 60 Hz 3450 rpm motors. 50 Hz 2875 rpm curves are available. These curves are for general guidance only, individual pump curves are available upon request. A certified curve may be requested for an additional cost. Webtrol will build pumps to fit your specific needs, contact factory for pricing.

VERTICAL SERIES BOOSTER - 300 Series

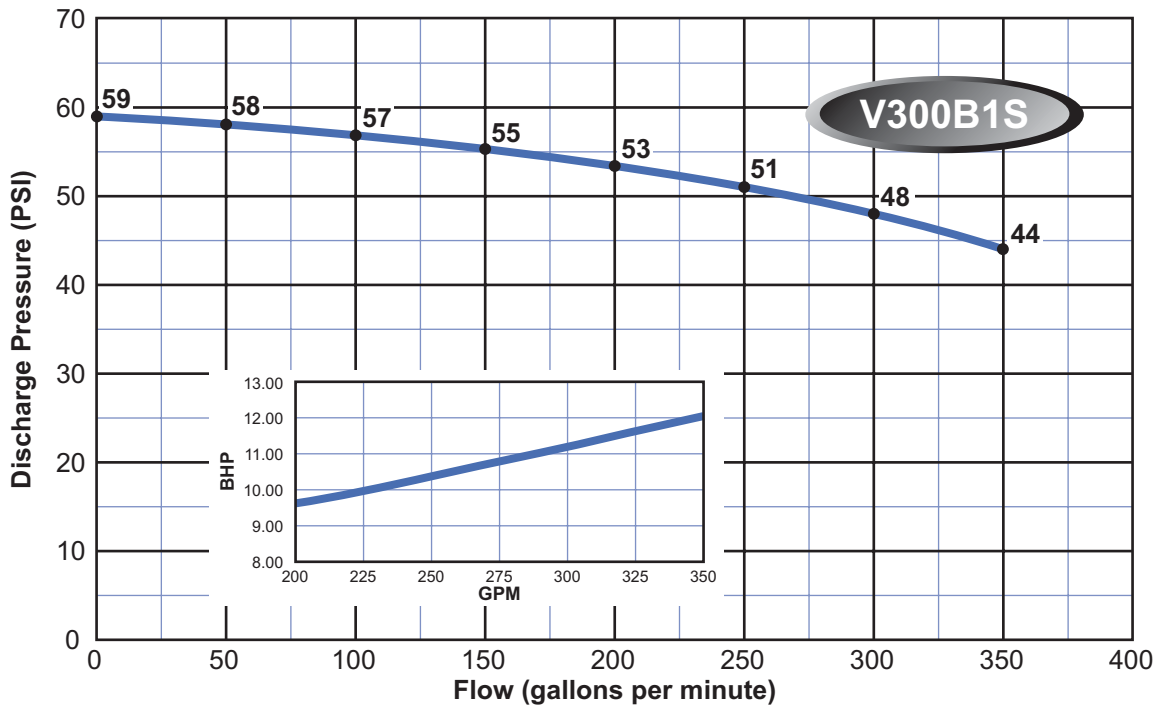
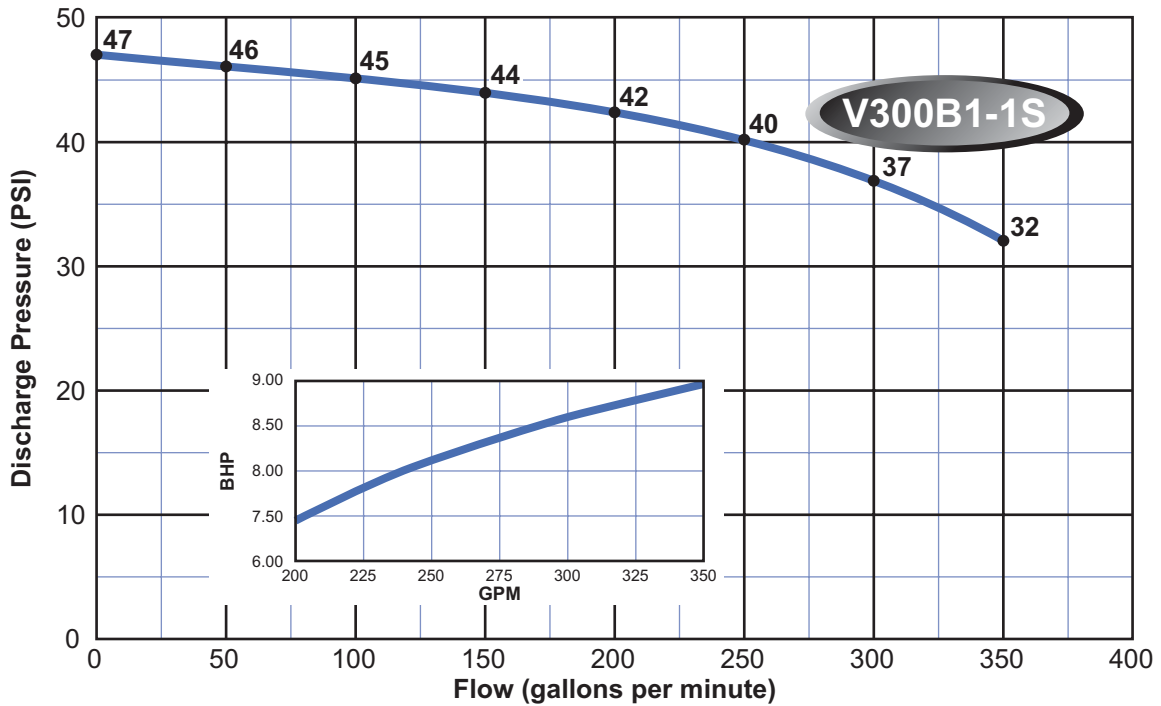

Note:

Curves are based on 60 Hz 3450 rpm motors. 50 Hz 2875 rpm curves are available. These curves are for general guidance only, individual pump curves are available upon request. A certified curve may be requested for an additional cost. Webtrol will build pumps to fit your specific needs, contact factory for pricing.

VERTICAL SERIES BOOSTER - 300 Series

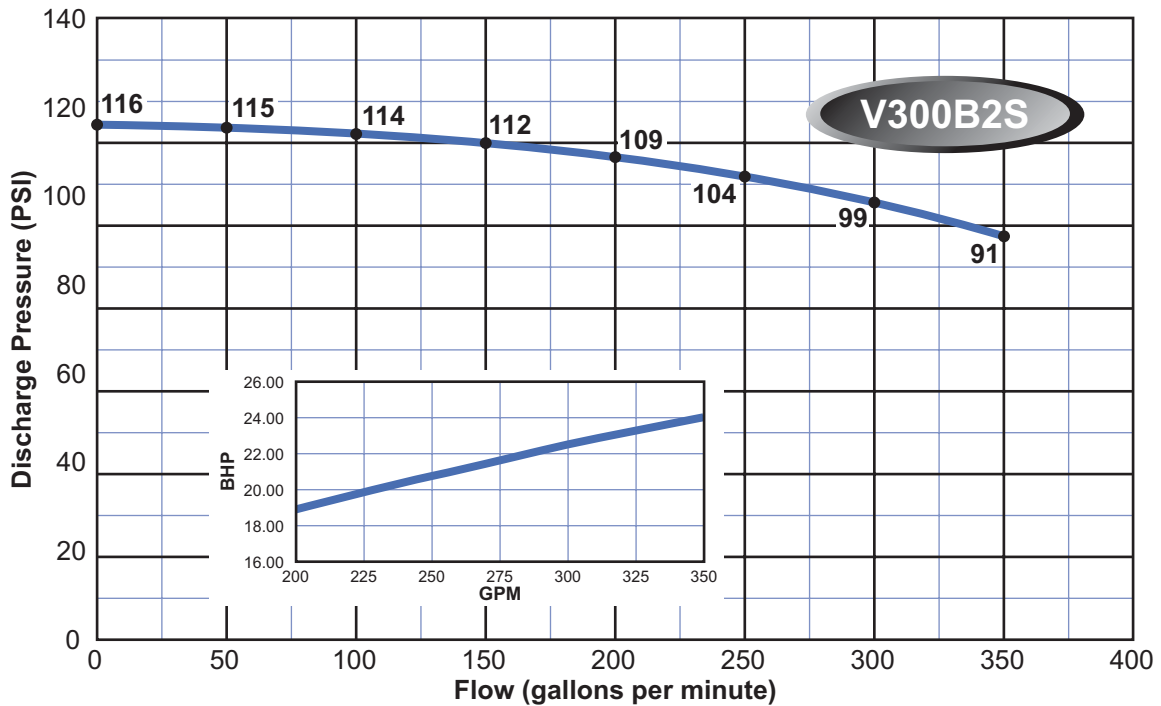
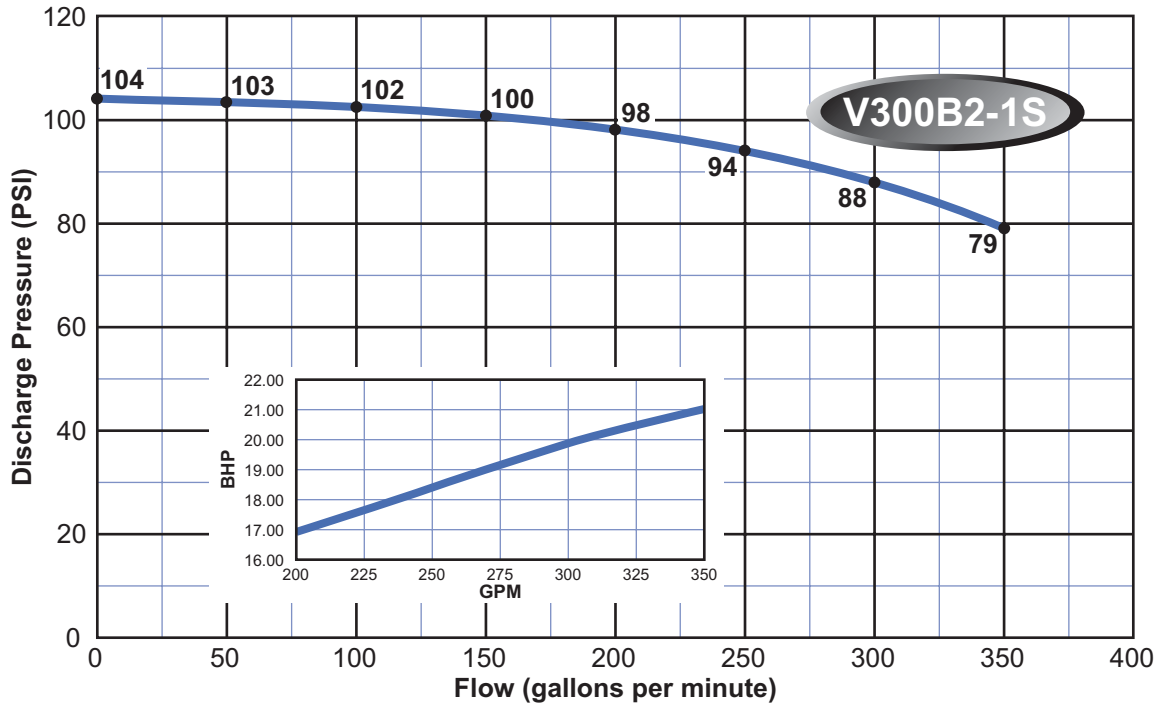

Note:

Curves are based on 60 Hz 3450 rpm motors. 50 Hz 2875 rpm curves are available. These curves are for general guidance only, individual pump curves are available upon request. A certified curve may be requested for an additional cost. Webtrol will build pumps to fit your specific needs, contact factory for pricing.

VERTICAL SERIES BOOSTER - 300 Series

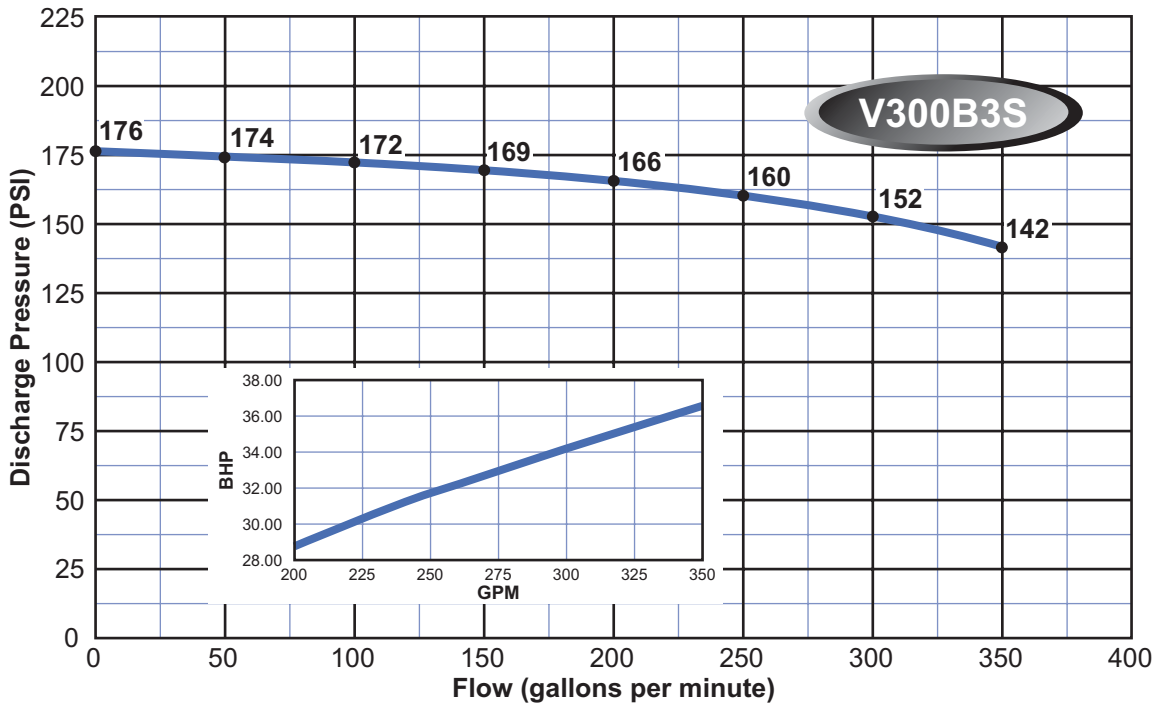
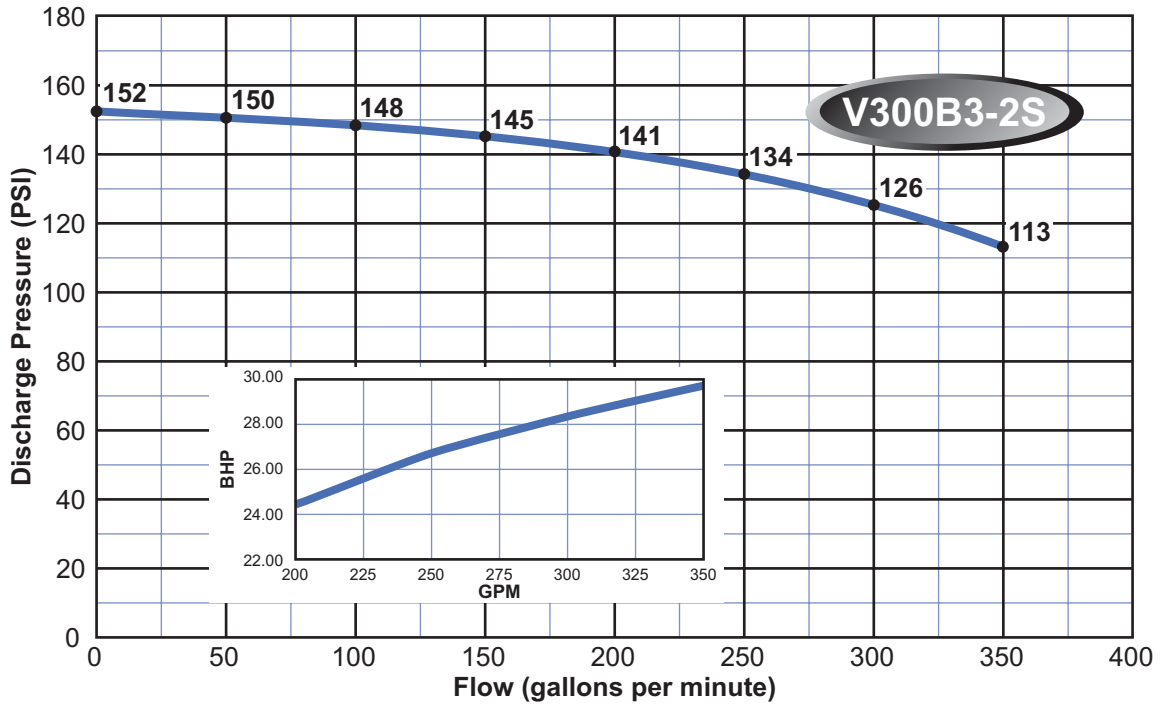

Note:

Curves are based on 60 Hz 3450 rpm motors. 50 Hz 2875 rpm curves are available. These curves are for general guidance only, individual pump curves are available upon request. A certified curve may be requested for an additional cost. Webtrol will build pumps to fit your specific needs, contact factory for pricing.

VERTICAL SERIES BOOSTER - 300 Series

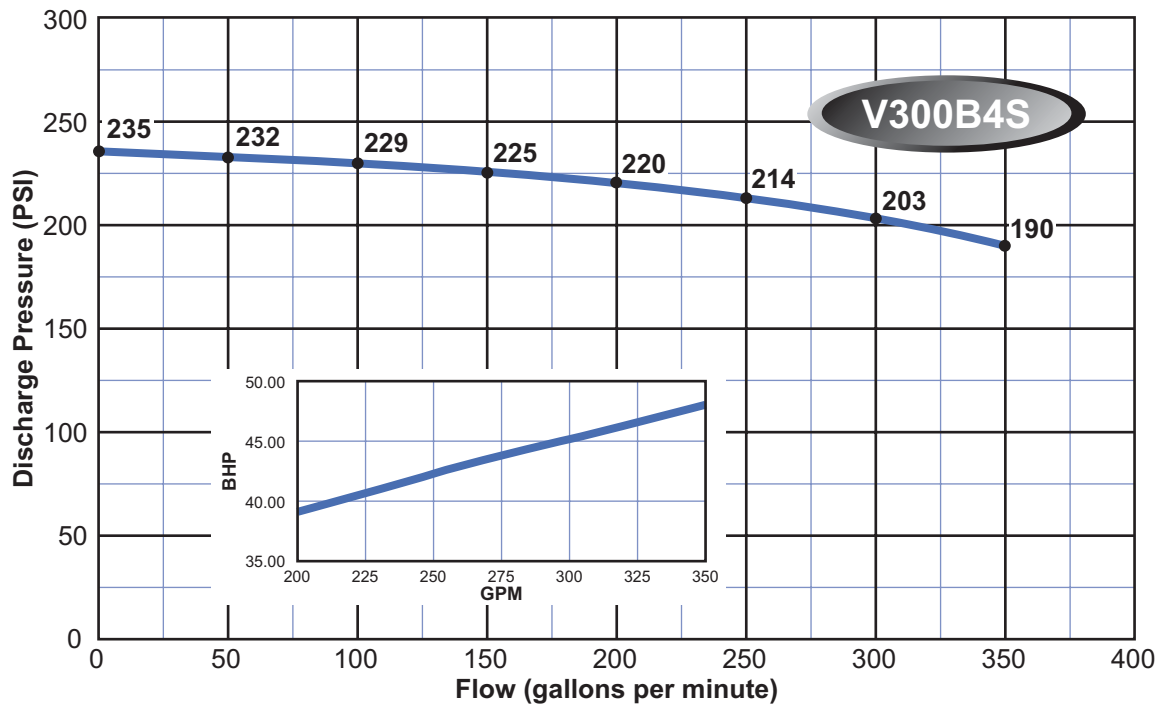
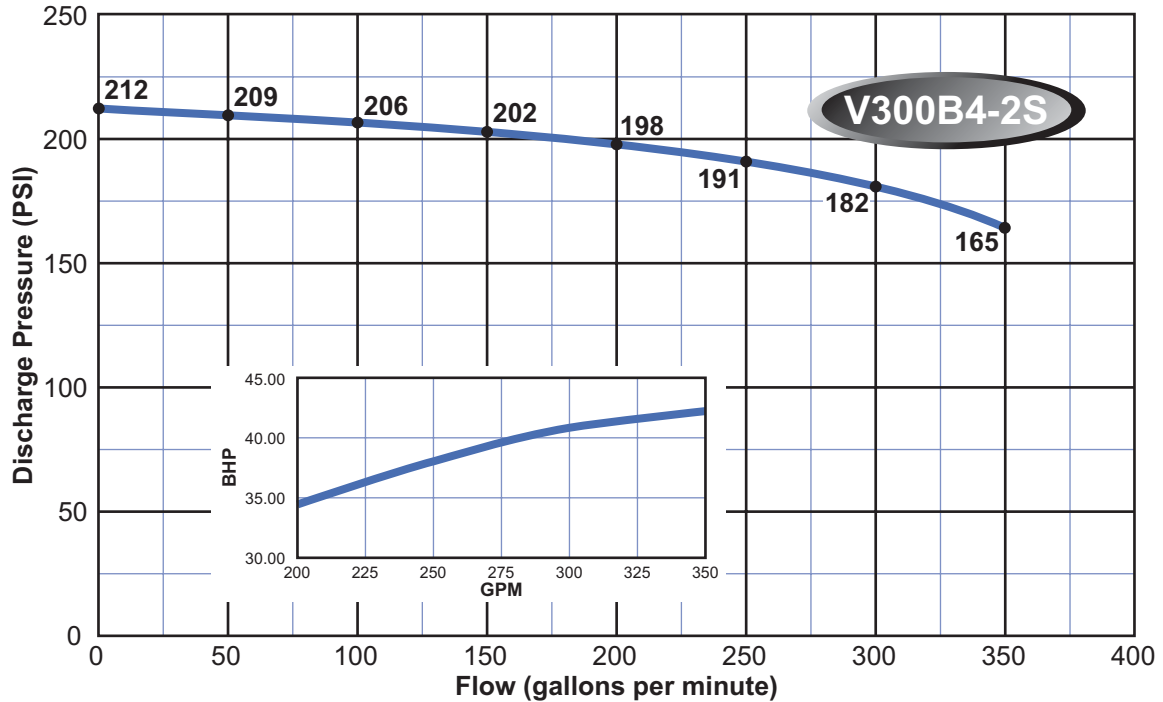

Note:

Curves are based on 60 Hz 3450 rpm motors. 50 Hz 2875 rpm curves are available. These curves are for general guidance only, individual pump curves are available upon request. A certified curve may be requested for an additional cost. Webtrol will build pumps to fit your specific needs, contact factory for pricing.

VERTICAL SERIES BOOSTER DIMENSIONS

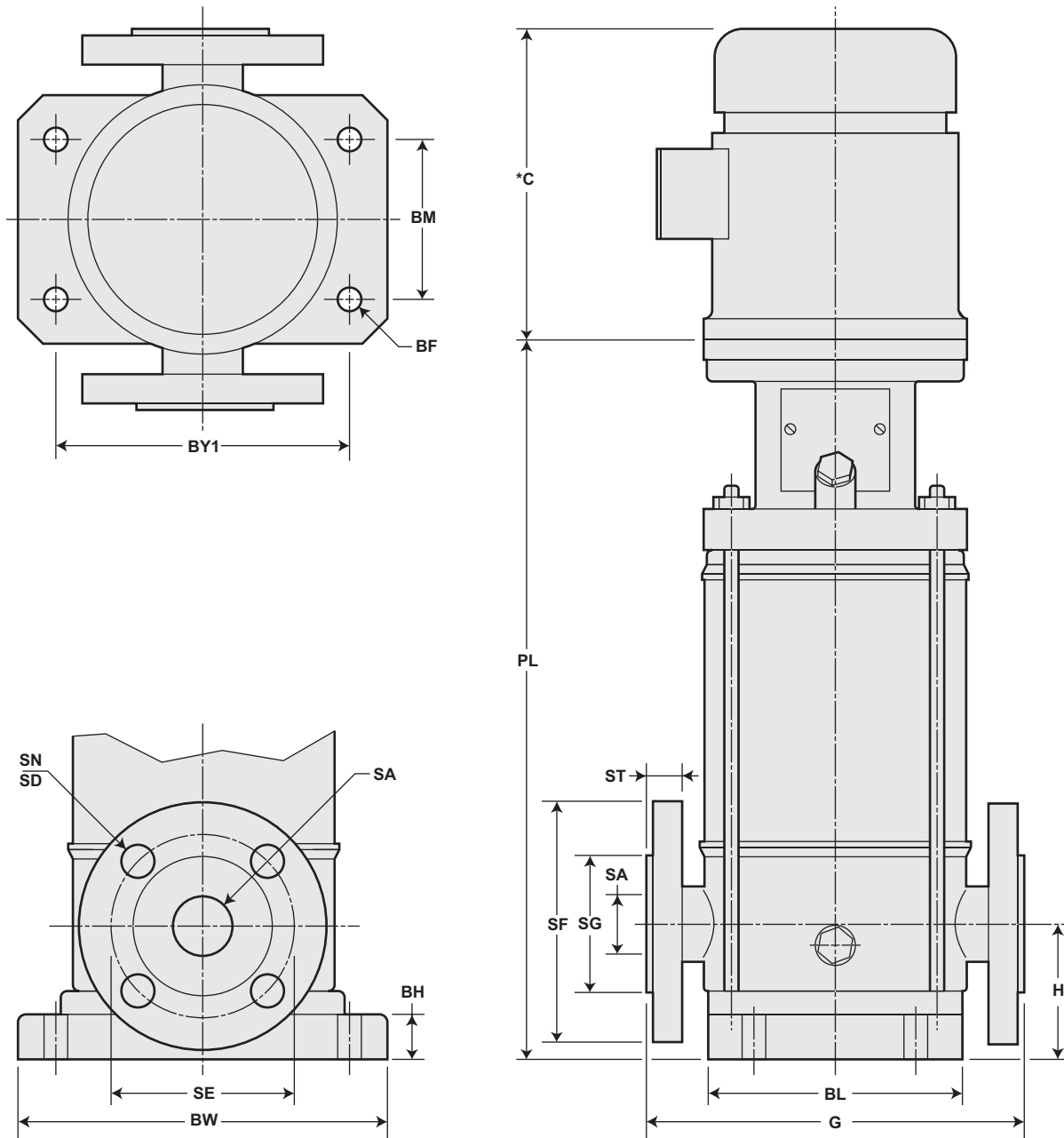

Note: *C = Motor Dimension - refer to motor manufacturer's catalog



VERTICAL SERIES BOOSTER DIMENSIONS V10 - V70

MODEL NO.	HP	FRAME	PL	H	G	ST	SA	SG	SF	SD	SN	SE	BM	BY1	BL	BW	BF	BH
V10B2S	0.50	56C	11 5/16															
V10B3S	0.75	56C	12 9/64															
V10B4S	1	56C	12 31/32															
V10B5S	1.5	143TC	13 55/64															
V10B6S	1.5	143TC	14 11/16															
V10B7S	2	145TC	15 17/32	2 61/64	9 27/32	23/32	1 3/8	2 63/64	5 33/64	3/4	4	3 7/8	3 15/16	7 3/32	5 55/64	8 17/64	15/32	25/32
V10B9S	3	145TC	17 3/16															
V10B11S	3	145TC	18 27/32															
V10B13S	3	145TC	20 57/64															
V10B15S	5	184TC	22 57/64															
V10B18S	5	184TC	25 3/8															
V20B2S	0.75	56C	11 7/8															
V20B3S	1.5	143TC	13 1/32															
V20B4S	2	145TC	14 9/64															
V20B5S	2	145TC	15 15/64															
V20B6S	3	145TC	16 23/64															
V20B7S	3	145TC	17 55/64															
V20B8S	3	145TC	18 61/64	2 61/64	9 27/32	23/32	1 3/8	2 63/64	5 33/64	3/4	4	3 7/8	3 15/16	7 3/32	5 55/64	8 17/64	15/32	25/32
V20B10S	5	184TC	21 33/64															
V20B11S	5	184TC	22 5/8															
V20B12S	5	184TC	23 23/32															
V20B14S	7.5	184TC	25 59/64															
V20B16S	7.5	184TC	28 5/32															
V40B2S	1.5	143TC	14 1/64															
V40B3S	3	145TC	15 13/64															
V40B4S	3	145TC	16 49/64															
V40B5S	5	184TC	18 13/16															
V40B6S	5	184TC	20															
V40B8S	7.5	184TC	22 3/8	3 35/64	11 51/64	23/32	1 31/32	4 1/64	6 1/2	3/4	8	5	5 1/8	8 15/32	7 31/64	9 27/32	15/32	25/32
V40B10S	7.5	213TC	24 3/4															
V40B12S	10	215TC	27 7/64															
V40B14S	15	215TC	29 41/64															
V40B16S	15	215TC	32															
V70B2S	5	184TC	15 9/16															
V70B3S	7.5	184TC	17 41/64															
V70B4S	7.5	184TC	19 7/32															
V70B5S	10	215TC	20 25/32															
V70B6S	15	215TC	22 9/16	3 35/64	11 51/64	23/32	1 31/32	4 1/64	6 1/2	3/4	8	5	5 1/8	8 15/32	7 31/64	9 27/32	15/32	25/32
V70B7S	15	215TC	24 9/64															
V70B8S	15	215TC	25 45/64															
V70B10S	20	256TC	28 55/64															
V70B11S	25	284TSC	30 37/64															

Note: All measurements are in inches.

Flange Dimensions & Accessories

Model No.	Suction/Discharge	Flange	Flange Part No.	Bolt Kit Part No.	Gasket Part No.
V10 & V20	ANSI 300 Lb	1 1/4" - 4 Bolt	29VT125-S	29VT125-SK	28V125-M
V40 & V70	ANSI 300 Lb	2" - 8 Bolt	29VT200-S	29VT200-SK	28V200-M

Note: Accessories purchased separately.



VERTICAL SERIES BOOSTER DIMENSIONS V140 - V300

MODEL NO.	HP	FRAME	PL	H	G	ST	SA	SG	SF	SD	SN	SE	BM	BY1	BL	BW	BF	BH
V140B1S	5	184TC	18 3/16															
V140B2-2S	7 1/2	184TC	20 19/32															
V140B3-2S	10	215TC	22 31/64			27/32			7	25/32	4	5 1/2						
V140B3S	15	215TC	27 41/64															
V140B4-3S	15	215TC	29 17/32															
V140B5S	20	256TC	31 27/64	4 9/64	12 9/32		2 9/16	4 21/64					6 11/16	9 29/64	8 17/64	11 1/32	35/64	1 3/8
V140B6S	25	284TSC	33 7/64															
V140B7S	30	286TSC	35															
V140B8-3S	30	286TSC	36 57/64			1 1/16			7 1/2	29/32	8	5 7/8						
V140B9S	40	324TSC	39 3/8															
V140B10-1S	40	324TSC	41 17/64															
V200B1-1S	7 1/2	184TC	21 29/64															
V200B1S	10	215TC	21 29/64															
V200B2-1S	15	215TC	29 29/64			15/16			7 1/2	25/32	4	6						
V200B3-2S	20	256TC	32 9/32															
V200B3S	25	284TSC	32 1/16	5 33/64	14 3/8		3 5/32	4 23/32					7 31/64	10 15/32	9 57/64	13 1/32	35/64	1 49/64
V200B4-1S	30	286TSC	34 59/64															
V200B5S	40	324TSC	38 11/32															
V200B6S	50	326TSC	41 3/16			1 13/64			8 1/4	29/32	8	6 5/8						
V200B7-2S	50	326TSC	44 1/64															
V300B1-1S	10	215TC	21 29/64															
V300B1S	15	215TC	26 5/8															
V300B2-1S	20	256TC	29 29/64			1 1/32			9	25/32		7 1/2						
V300B2S	25	284TSC	29 1/4	5 33/64	14 3/8		3 15/16	5 33/64			8		7 31/64	10 15/32	9 57/64	13 1/32	35/64	1 49/64
V300B3-2S	30	286TSC	32 3/32															
V300B3S	40	324TSC	32 11/16															
V300B4-2S	40	324TSC	35 33/64			1 21/64			10	29/32		7 7/8						
V300B4S	50	326TSC	35 33/64															

Note: All measurements are in inches.

Flange Dimensions & Accessories

Model No.	Suction/Discharge	Flange	Flange Part No.	Bolt Kit Part No.	Gasket Part No.
V140B1S - V140B4-3S	ANSI 150 Lb	2 1/2" - 4 Bolt	29T250-S	29T250-SK	28V250-M
V140B5S - V140B10-1S	ANSI 300 Lb	2 1/2" - 8 Bolt	29VT250-S	29VT250-SK	28V250-M
V200B1-1S - V200B3S	ANSI 150 Lb.	3" - 4 Bolt	29T300-S	29T300-SK	28V300-M
V200B4-1S - V200B7-2S	ANSI 300 Lb.	3" - 8 Bolt	29VT300-S	29VT300-SK	28V300-M
V300B1-1S - V300B4S	ANSI 300 Lb.	4" - 8 Bolt	29VT400-S	29VT400-SK	28V400-M

Note: Accessories purchased separately.